



Merchandising 2013

INDICE:

- ESPOSITORI _____ 4

- RASTRELLIERE _____ 10

- MERCHANDISING DELLE SERIE:

- Absolute Stone _____ 11

- Acquerelli _____ 13

- Canova _____ 16

- Cotto Reale _____ 18

- Crystal Ker Leather _____ 20

- Crystal Ker Luxoring _____ 25

- Crystal Ker Loft _____ 28

- Crystal Ker Wood _____ 29

- Diamond _____ 31

- Ecostone _____ 36

- Infinity Stone _____ 39

- Karma _____ 41

- Le Filigrane _____ 44

- Light Stone _____ 47

- Lirica _____ 49

- Luminor _____ 53

- Luminor XS _____ 54

- Natural _____ 57

- Onice _____ 61

- Open Space _____ 66

- Perla _____ 68

- Pietra del Nord _____ 71

- Textile _____ 73

- Varenna _____ 75

- Velvet _____ 78

- Via della Seta _____ 81

- Walk _____ 83



STRUTTURA PER PAVIMENTI
E RIVESTIMENTI

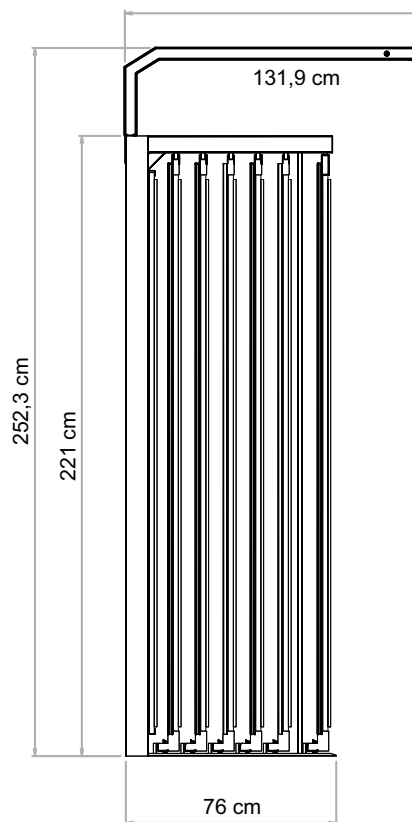
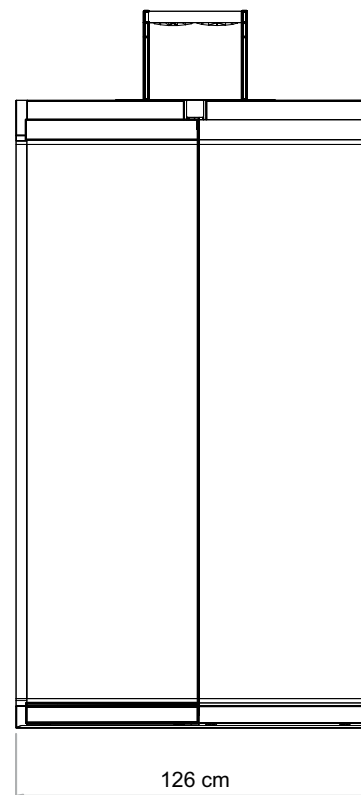
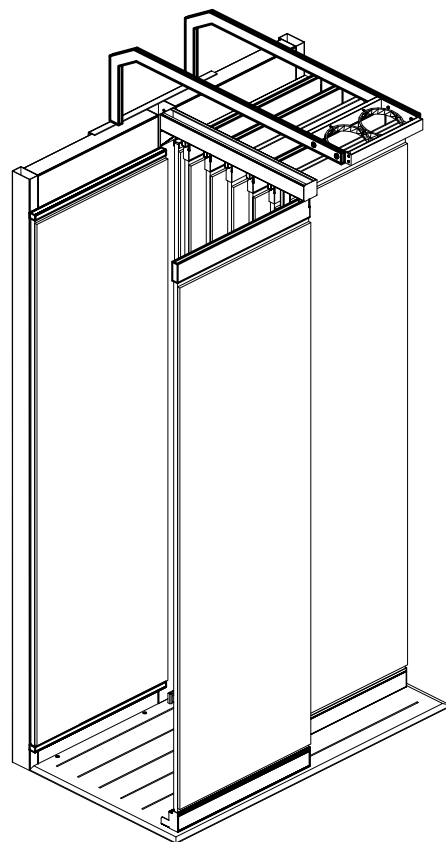

ESPOSITORE SCORREVOLE 60x200

OGGETTO

6100712

CODICE

1 struttura per 8 pannelli 60x200

€ 950,00 (costo sola struttura)

PREZZO

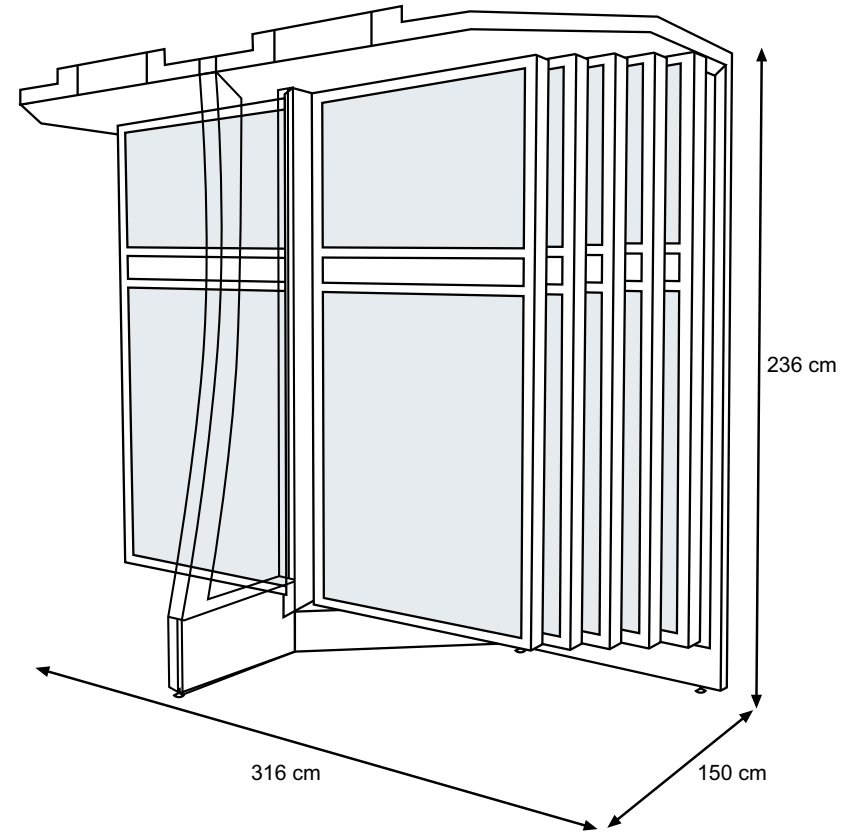

STRUTTURA PER PAVIMENTI E RIVESTIMENTI

ESPOSITORE LIBRO 20 PANNELLI 100,5x201

OGGETTO

6100700

CODICE

1 struttura per 20 pannelli 100,5x201

€ 2015,00 (costo sola struttura)

PREZZO



STRUTTURA PER PAVIMENTI E RIVESTIMENTI

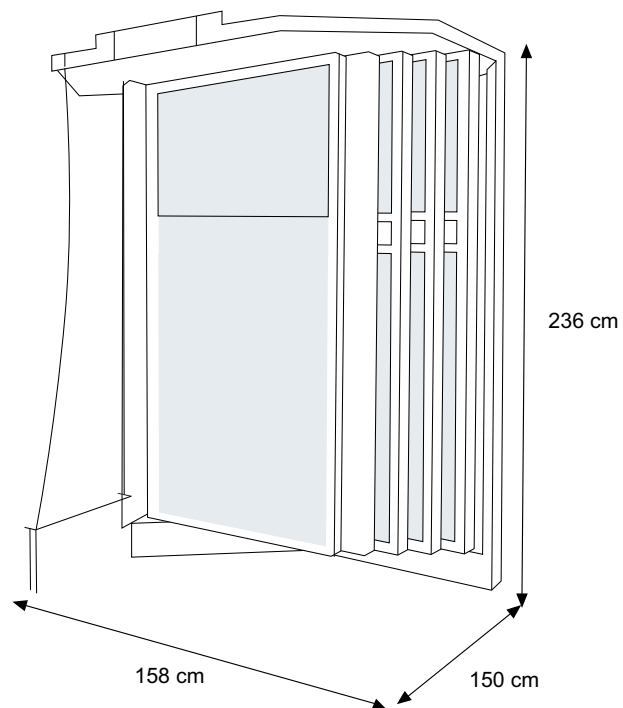

ESPOSITORE LIBRO 10 PANNELLI 100,5x201 SX

OGGETTO

6100703

CODICE

1 struttura per 10 pannelli 100,5x201

€ 1065,00 (costo sola struttura)

PREZZO



STRUTTURA PER PAVIMENTI
E RIVESTIMENTI

ESPOSITORE LIBRO 10 PANNELLI 100,5x201 DX

OGGETTO

6100702

CODICE

1 struttura per 10 pannelli 100,5x201

€ 1065,00 (costo sola struttura)

PREZZO



STRUTTURA PER PAVIMENTI E RIVESTIMENTI

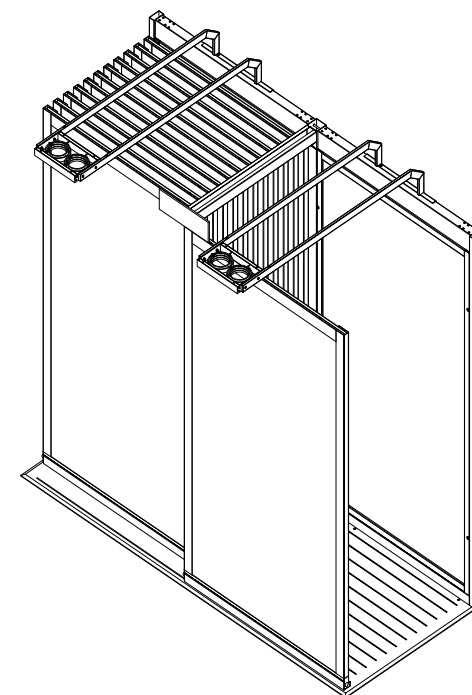
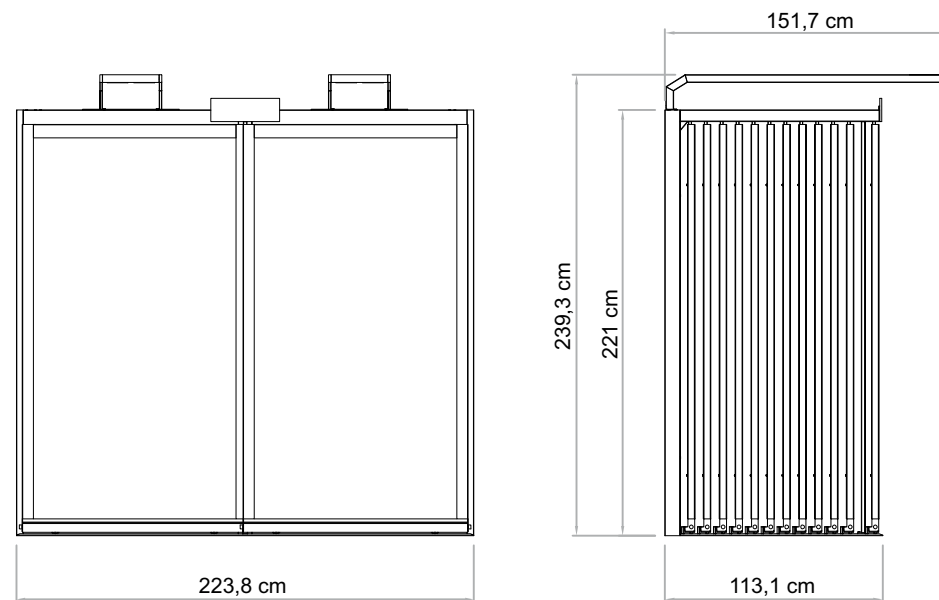

ESPOSITORE SCORREVOLE 14 PANNELLI 100,5x201

OGGETTO

6100714

CODICE

1 struttura per 14 pannelli 100,5x201

€ 2500,00 (costo sola struttura)

PREZZO



STRUTTURA PER PAVIMENTI

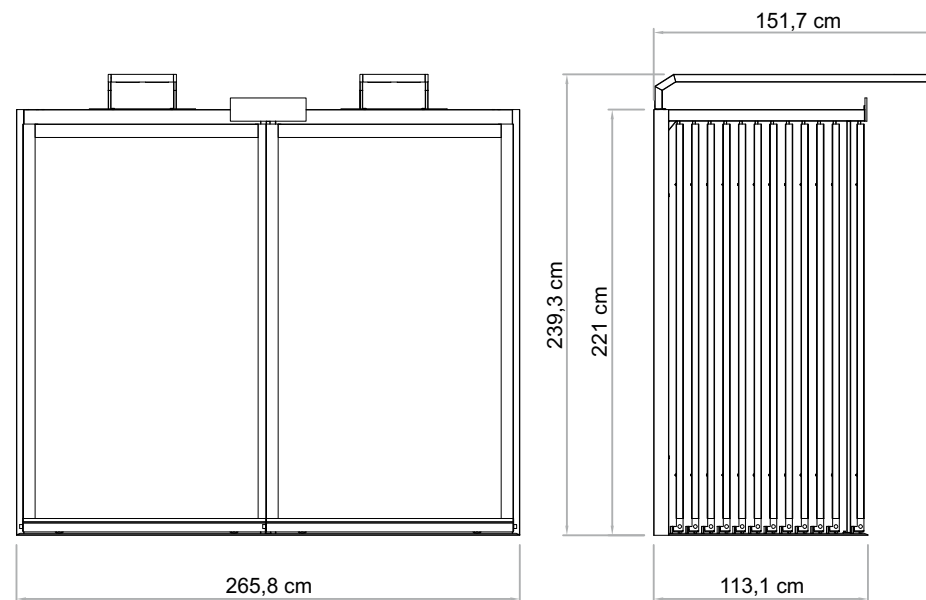

ESPOSITORE SCORREVOLE 14 PANNELLI 120,5x201

OGGETTO

6100711

CODICE

1 struttura per 14 pannelli 120,5x201

€ 2610,00 (costo sola struttura)

PREZZO

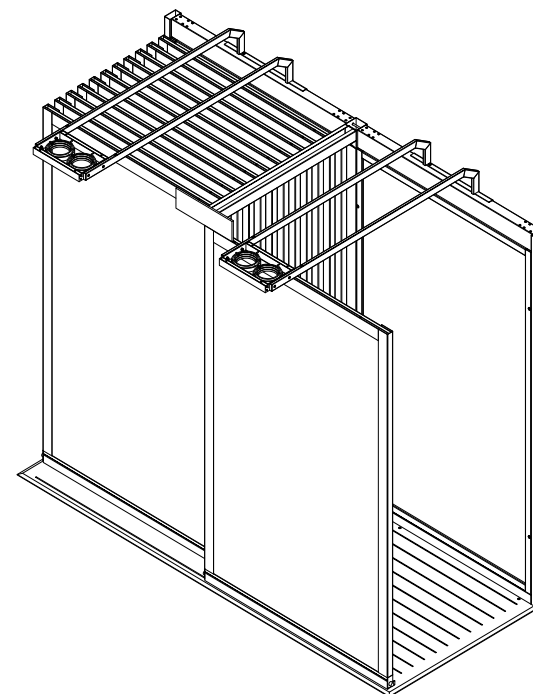



STRUTTURA PER PAVIMENTI

ESPOSITORE SCORREVOLE 27 PANNELLI 120,5x201

OGGETTO

6100713

CODICE

1 struttura per 27 pannelli 120,5x201

€ 4870,00 (costo sola struttura)

PREZZO

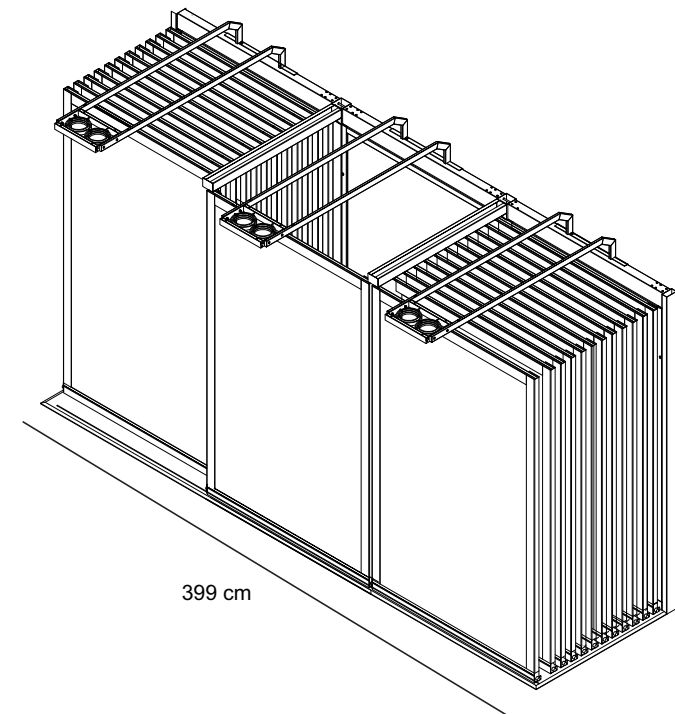
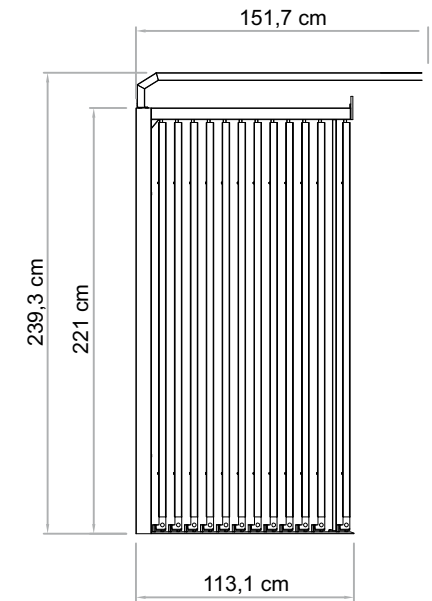

DA UTILIZZARE SOLO PER FORMATI GRANDI 120x120, 60x120, 60x90

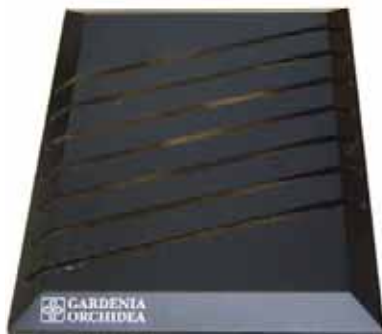

RASTRELLIERA DIAMANTE 7pz
(per formati fino a 60x60)

OGGETTO
6000957
CODICE
€ 80,00 (sola rastrelliera)
PREZZO
cm 60x80x5 (sola rastrelliera)
MISURE



RASTRELLIERA GRANDI FORMATI
7pz LINEARE

OGGETTO
6001101
CODICE
€ 98,00 (sola rastrelliera)
PREZZO
cm 60x90x5 (sola rastrelliera)
MISURE



RASTRELLIERA GRANDI FORMATI
7pz IN SALITA

OGGETTO
6001090
CODICE
€ 148,00 (sola rastrelliera)
PREZZO
cm 51x94x70 (sola rastrelliera)
MISURE

INSERIRE GLI ORDINI CON CODICE RASTRELLIERA + CODICE MATERIALE
(ABSOLUTE STONE, INFINITY STONE o OPEN SPACE):

CODICE PIETRA DEL NORD: 6001113 € 35,00
CODICE LIGHT STONE: 6001114 € 25,00
CODICE NATURAL: 6001117 € 36,00

CODICE ABSOLUTE STONE: 6001110 € 85,00
CODICE INFINITY STONE: 6001111 € 160,00
CODICE OPEN SPACE: 6001112 € 150,00
CODICE NATURAL 80x80: 6001118 € 70,00
CODICE WALK 80x80: 6001119 € 70,00

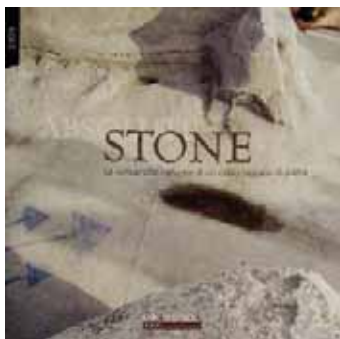

DEPLIANT ABSOLUTE STONE

OGGETTO

6002075

CODICE

€ 2,00

PREZZO



RASTRELLIERA ABSOLUTE STONE

OGGETTO

Indicare: 1 codice rastrelliera +
1 codice materiale
(vedi rastrelliere pag. 10)

CODICE

€ 183,00

(culla lineare + set piastrelle Absolute Stone)

€ 233,00

(culla in salita + set piastrelle Absolute Stone)

PREZZO



ESEMPIO:

RASTRELLIERA GRANDI FORMATI IN SALITA
+ 7pz ABSOLUTE STONE 60x90

COD 6001090 + COD 6001110

€ 233,00

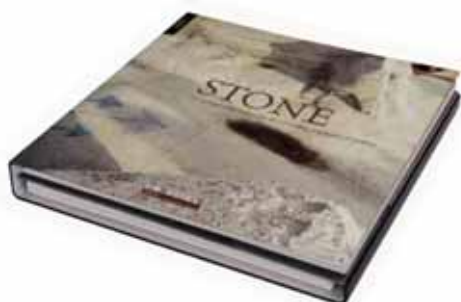

TOZZETTARIO ABSOLUTE STONE

OGGETTO

6000923

CODICE

€ 39,10

PREZZO



PANNELLO ABSOLUTE WENGE' cm 256x140

OGGETTO

ABS0001

CODICE

€ 750,00

PREZZO

PANNELLI 100,5x201 - 120,5x201

SCHEMA A
AS00003/A

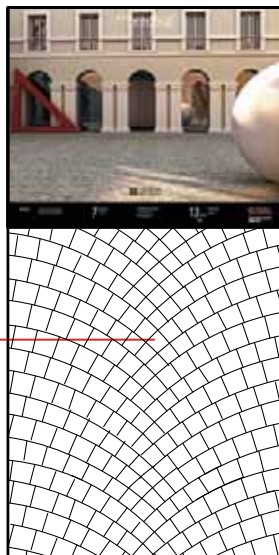

pavè 30x60

€ 105,00

SCHEMA B
AS00003/B

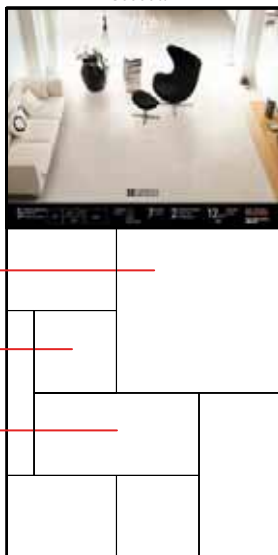

fondo 60x60

fondo 30x30

fondo 30x60

€ 105,00

SCHEMA C
AS00003/C

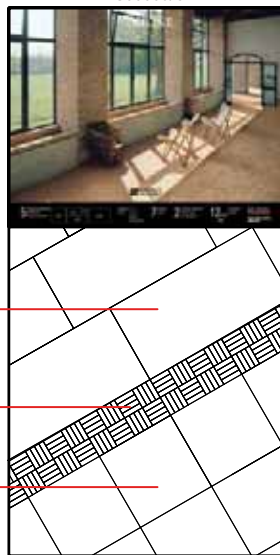

fondo 30x60

mosaico 64 mod
30x30

fondo 30x30

€ 105,00

SCHEMA D
AS00003/D



fondo 60x60

mosaico 64 mod
30x30

fondo 30x60

€ 105,00

RIASSUNTIVO
ASGRA10/0



€ 105,00

PER OGNI SCHEMA DI POSA SCELTO È NECESSARIO INDICARE NEL COMMENTO IL COLORE E LA SUPERFICIE (NAT O LAP) CHE SI VUOLE POSARE. LA FOTO VERRÀ APPLICATA DI CONSEGUENZA.

15776 NERO LAPPATO 60x90

TOZZETTI COLORE:

- ALMOND NAT E LAP
- ORO NAT E LAP
- NOCE NAT E LAP
- VERDE NAT E LAP
- ANTRACITE NAT E LAP
- BIANCO NAT E LAP
- NERO NAT E LAP



DEPLIANT ACQUERELLI

OGGETTO

6002107

CODICE

€ 2,00

PREZZO



115 cm

100 cm

68 cm

CULLA ACQUERELLI

OGGETTO

6001102

CODICE

€ 335,00

PREZZO

PANNELLI CULLA



AZZURRO/BIANCO

- 62310 TORELLO BIANCO 4x50
- 62375 LISTELLO RIGHE AZZURRO 3x50
- 62300 BIANCO 20x50
- 62365 PENNELLATO AZZURRO 6,2x50
- 62305 AZZURRO 20x50



TABACCO/AVORIO

- 62312 TORELLO TABACCO 4x50
- 62351 LISTELLO STENCIL AVORIO 6,2x50
- 62332 MATITA TABACCO 1x50
- 62301 AVORIO
- 62302 TABACCO 20x50



LILLA/BIANCO

- 62366 LISTELLO PENNELLATO LILLA 6,2x50
- 62300 BIANCO 20x50
- 61045 PROFILO ARGENTO 0,5x50
- 62376 LISTELLO RIGHE LILLA 3x50
- 62306 LILLA 20x50



VERDE/AVORIO

- 62314 TORELLO VERDE 4x50
- 62301 AVORIO 20x50
- 62334 MATITA VERDE 1x50
- 62354 LISTELLO STENCIL VERDE 6,2x50
- 62304 VERDE 20x50



GRIGIO/BIANCO

- 62373 LISTELLO RIGHE GRIGIO 3x50
- 62380 MODULO RIGHE BIANCO 20x50
- 61045 PROFILO ARGENTO 0,5x50
- 62303 GRIGIO 20x50



14350 BIANCO 41x41



14351 AVORIO 41x41



14352 TABACCO 41x41



14353 GRIGIO 41x41



14354 VERDE 41x41



14355 AZZURRO 41x41



14356 LILLA 41x41

PANNELLI 60x200



AVORIO/TABACCO

OGGETTO

AC10001

CODICE

€ 88,00

PREZZO

62312 TORELLO TABACCO 4x50
62351 LISTELLO STENCIL AVORIO 6,2x50
62332 MATITA TABACCO 1x50
62301 AVORIO 20x50
62302 TABACCO 20x50



BIANCO/GRIGIO

OGGETTO

AC10002

CODICE

€ 88,00

PREZZO

62300 BIANCO 20x50
62373 LISTELLO RIGHE GRIGIO 3x50
62380 MODULO BIANCO 20x50
62303 GRIGIO 20x50



AVORIO/VERDE

OGGETTO

AC10003

CODICE

€ 88,00

PREZZO

62314 TORELLO VERDE 4x50
62301 AVORIO 20x50
62354 LISTELLO STENCIL VERDE 6,2x50
62334 MATITA VERDE 1x50
62304 VERDE 20x50



BIANCO/LILLA

OGGETTO

AC10000

CODICE

€ 88,00

PREZZO

62376 LISTELLO RIGHE LILLA 3x50
62300 BIANCO 20x50
62386 MODULO LILLA 20x50
62306 LILLA 20x50



BIANCO/AZZURRO

OGGETTO

AC10004

CODICE

€ 88,00

PREZZO

62365 LISTELLO RIGHE AZZURRO 3x50
62300 BIANCO 20x50
62385 MODULO AZZURRO 20x50
62305 AZZURRO 20x50

PANNELLI 100,5x201



AVORIO/TABACCO

OGGETTO

ACGRAF2

CODICE

€ 88,00

PREZZO

62312 TORELLO TABACCO 4x50
62351 LIST STENCIL AVORIO 6,2x50
62332 MATITA TABACCO 1x50
62301 AVORIO 20x50
62302 TABACCO 20x50

PAVIMENTI
14352 TABACCO 41x41



BIANCO/GRIGIO

OGGETTO

ACGRAF3

CODICE

€ 88,00

PREZZO

62300 BIANCO 20x50
62373 LIST RIGHE GRIGIO 3x50
62380 MODULO BIANCO 20x50
62303 GRIGIO 20x50

PAVIMENTI
14353 GRIGIO 41x41



AVORIO/VERDE

OGGETTO

ACGRAF4

CODICE

€ 88,00

PREZZO

62314 TORELLO VERDE 4x50
62354 LISTELLO STENCIL VERDE 6,2x50
62334 MATITA VERDE 1x50
62301 AVORIO 20x50
62304 VERDE 20x50

PAVIMENTI
14354 VERDE 41x41



BIANCO/LILLA

OGGETTO

ACGRAF6

CODICE

€ 88,00

PREZZO

62300 BIANCO 20x50
62376 LISTELLO RIGA LILLA 3x50
62386 MODULO RIGA LILLA 20x50
62306 LILLA 20x50

PAVIMENTI
14356 LILLA 41x41



BIANCO/AZZURRO

OGGETTO

ACGRAF5

CODICE

€ 88,00

PREZZO

62300 BIANCO 20x50
62375 LISTELLO RIGA AZZURRO 3x50
62385 MODULO RIGA AZZURRO 20x50
62305 AZZURRO 20x50

PAVIMENTI
14355 AZZURRO 41x41

PANNELLI CULLA

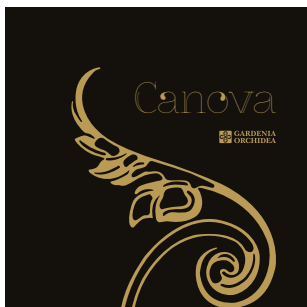

DEPLIANT CANOVA

OGGETTO

6002122

CODICE

€ 2,00

PREZZO

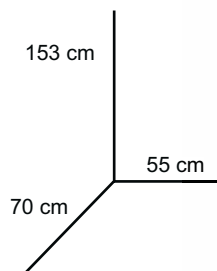

CULLA CANOVA

OGGETTO

6001121

CODICE

€ 300,00

PREZZO



BIANCO

- 69065 TORELLO BIANCO 6x25
- 69120 LISTELLO BIANCO 8x25
- 69000 BIANCO 25x60
- 69075 MATITA BIANCO 1x25
- 69010 MOSAICO BIANCO 25x60
- 69055 BATTISCOPA RILIEVO BIANCO 15x25
- 17398 MOSAICO PAVIMENTO BIANCO 25x25
- 17395 ANGOLO DECORATO BIANCO 25x25



BEIGE

- 69091 LISTELLO RILIEVO BEIGE 8x25
- 69011 MOSAICO BEIGE 25x60
- 69001 BEIGE 25x60
- 69056 BATTISCOPA RILIEVO BEIGE 8x25
- 17399 MOSAICO PAVIMENTO BEIGE 25x25



17440 BIANCO 50x50



17441 BEIGE 50x50

PANNELLI 100,5x201



BIANCO

OGGETTO

CAGRAF1

CODICE

€ 100,00

PREZZO



BEIGE

OGGETTO

CAGRAF2

CODICE

€ 100,00

PREZZO

69065 TORELLO BIANCO 6x25
69120 LISTELLO BIANCO 8x25
69010 MOSAICO BIANCO 6x25
69075 MATITA BIANCO 1x25
69000 BIANCO 25x60
69055 BATTISCOPA RILIEVO BIANCO 15x25

PAVIMENTI
17440 BIANCO 50x50

69091 LISTELLO RILIEVO 8x25
69011 MOSAICO BEIGE 25x60
69001 BEIGE 25x60
69056 BATTISCOPA RILIEVO BEIGE 15x25

PAVIMENTI
17441 BEIGE 50x50

PANNELLI 60x200



BIANCO

OGGETTO

CA10000

CODICE

€ 100,00

PREZZO



BEIGE

OGGETTO

CA10001

CODICE

€ 100,00

PREZZO

69065 TORELLO BIANCO 6x25
69120 LISTELLO BIANCO 8x25
69000 BIANCO 25x60
69075 MATITA BIANCO 1x25
69010 MOSAICO BIANCO 6x25
69055 BATTISCOPA RILIEVO BIANCO 15x25

69091 LISTELLO RILIEVO 8x25
69011 MOSAICO BEIGE 25x60
69001 BEIGE 25x60



DEPLIANT COTTO REALE

OGGETTO

6002096

CODICE

€ 2,00

PREZZO



103,5 cm

75,5 cm

50 cm

CULLA COTTO REALE

OGGETTO

6001085

CODICE

€ 200,00

PREZZO

PANNELLI CULLA



BEIGE

19193 BEIGE 16,5x33,3
12006 ANGOLO MAIOLICA BEIGE 16,5x16,5



OCRA

19191 OCRA 16,5x33,3
12920 TOZZETTI ROSSO/OCRA/ROSA 7,8x7,8



ROSA

19242 ROSA 33,3x33,3
12022 FASCIA FLOREALE ROSA 16,5x33,3



ROSSO

19240 ROSSO 33,3x33,3
19190 ROSSO 16,5x33,3
12880 FASCIA PIETRE NATURALI ROSSO 16,5x33,3

PANNELLI 100,5x201 - 120,5x201

SCHEMA N2
CR00002

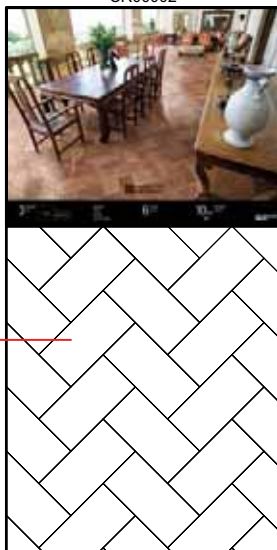

fondo 16,5x33,3

€ 100,00

SCHEMA N4
CR00004



fondo 16,5x33,3

fascia pietre naturali 16,5x33,3

fondo 33,3x33,3

€ 100,00

SCHEMA N5
CR00005



fondo 16,5x33,3

angolo maiolica 16,5x16,5

€ 100,00

SCHEMA N6
CR00006



fondo 16,5x33,3

tavella maiolica 16,5x33,3

fondo 33,3x33,3

€ 100,00

SCHEMA N7
CR00007



fondo 33,3x33,3

tavella maiolica 16,5x33,3

mosaico 33,3x33,3

€ 100,00

SCHEMA N9
CR00009



fondo 16,5x33,3

fondo 33,3x33,3

fondo 50x50

€ 100,00

PER OGNI SCHEMA DI POSA
INSERIRE CODICE CON VERSIONE
COLORE CHE SI VUOLE POSARE.
LA FOTO VERRÀ APPLICATA DI
CONSEGUENZA

CODICE 0 ROSSO
CODICE 1 OCRA
CODICE 2 ROSA
CODICE 3 BEIGE



DEPLIANT CRYSTAL KER LEATHER

OGGETTO

6002089

CODICE

€ 2,00

PREZZO



TOZZETTARIO CK LEATHER

OGGETTO

6000962

CODICE

€ 42,50

PREZZO

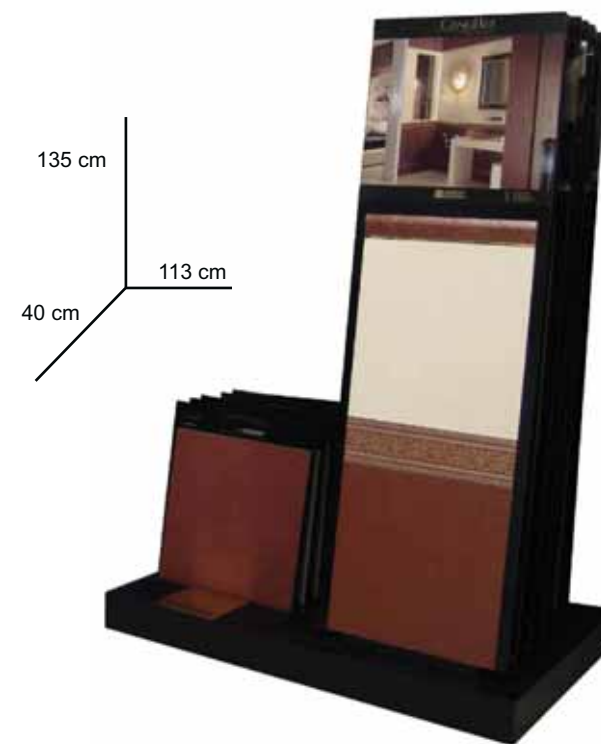

CULLA CRYSTAL KER LEATHER

OGGETTO

6001082

CODICE

€ 500,00

PREZZO

PANNELLI CULLA



NERO/ORO

- 21791 TORELLO NERO 4x33,3
- 21143 PROFILO ORO 0,5x33,3
- 21051 PELLE MEDIA NERO 33,3x33,3
- 21876 MOSAICO 64 MODULI ORO 33,3x33,3
- 21061 PELLE GROSSA NERO 33,3x33,3



BORDEAUX

- 21844 LISTELLO GIGLIO BORDEAUX 8x33,3
- 21050 PELLE MEDIA BIANCO 33,3x33,3
- 21794 TORELLO BORDEAUX 4x33,3
- 21143 PROFILO ORO 0,5x33,3
- 21864 MODULO RIGHE BORDEAUX 33,3x33,3



MOKA

- 21793 TORELLO MOKA 4x33,3
- 21843 LISTELLO GIGLIO MOKA 8x33,3
- 21052 MEDIO BEIGE 33,3x33,3
- 21141 PROFILO ORO 1x33
- 21833 MODULO GIGLIO MOKA 33,3x33,3



BEIGE

- 21792 TORELLO BEIGE 4x33,3
- 21143 PROFILO ORO 0,5x33,3
- 21052 PELLE MEDIA BEIGE 33,3x33,3
- 21842 LISTELLO GIGLIO BEIGE 8x33,3
- 21832 MODULO GIGLIO BEIGE 33,3x33,3



CUOIO

- 21795 TORELLO CUOIO 4x33,3
- 21143 PROFILO ORO 0,5x33,3
- 21052 PELLE MEDIA BEIGE 33,3x33,3
- 21845 LISTELLO GIGLIO CUOIO 8x33,3
- 21065 PELLE GROSSA CUOIO 33,3x33,3

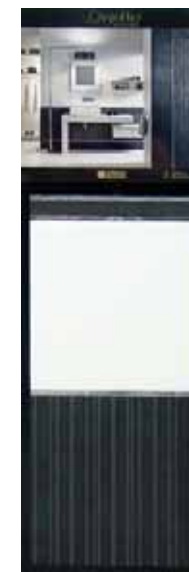

BIANCO/NERO

- 21791 TORELLO NERO 4x33,3
- 21140 PROFILO ACCIAIO 1x33,3
- 21050 PELLE MEDIA BIANCO 33,3x33,3
- 21861 MODULO RIGHE NERO 33,3x33,3



22161 NERO 33,3x33,3



22164 BORDEAUX 33,3x33,3



22163 MOKA 33,3x33,3



22162 BEIGE 33,3x33,3



22175 CUOIO 33,3x33,3



22160 BIANCO 33,3x33,3

PANNELLI 60x200



CK LEATHER NERO

OGGETTO

CK10016

CODICE

€ 98,00

PREZZO

21791 TORELLO NERO 4x33,3
21143 PROFILO ORO 0,5x33,3
21051 MEDIO NERO 33,3x33,3
21876 MOSAICO 64 ORO 33,3x33,3
21061 GROSSO NERO 33,3x33,3



CK LEATHER BORDEAUX

OGGETTO

CK10017

CODICE

€ 98,00

PREZZO

21794 TORELLO BORDEAUX 4x33,3
21143 PROFILO ORO 0,5x33,3
21054 MEDIO BORDEAUX 33,3x33,3
21714 DECORO CORNICE ORO/BORDEAUX 33,3x33,3
21874 MOSAICO 64 BORDEAUX 33,3x33,3



CK LEATHER BORDEAUX

OGGETTO

CK10013

CODICE

€ 98,00

PREZZO

21844 LISTELLO GIGLIO BORDEAUX 8x33,3
21050 MEDIO BIANCO 33,3x33,3
21794 TORELLO BORDEAUX 4x33,3
21143 PROFILO ORO 0,5x33,3
21864 MODULO RIGHE 33,3x33,3

PANNELLI 60x200



CK LEATHER BEIGE

OGGETTO

CK10015

CODICE

€ 98,00

PREZZO

21792 TORELLO BEIGE 4x33,3
21143 PROFILO ORO 0,5x33,3
21052 MEDIO BEIGE 33,3x33,3
21842 LISTELLO GIGLIO BEIGE 8x33,3
21832 MODULO GIGLIO 33,3x33,3



CK LEATHER CUOIO

OGGETTO

CK10014

CODICE

€ 98,00

PREZZO

21795 TORELLO CUOIO 4x33,3
21143 PROFILO ORO 0,5x33,3
21052 MEDIO BEIGE 33,3x33,3
21845 LISTELLO GIGLIO CUOIO 8x33,3
21065 GROSSO CUOIO 33,3x33,3



CK LEATHER NERO

OGGETTO

CK10012

CODICE

€ 98,00

PREZZO

21791 TORELLO NERO 4x33,3
21140 PROFILO ACCIAIO 1x33,3
21050 MEDIO BIANCO 33,3x33,3
21861 MODULO RIGHE NERO 33,3x33,3



CK LEATHER MOKA

OGGETTO

CK10010

CODICE

€ 98,00

PREZZO

21793 TORELLO MOKA 4x33,3
21843 LISTELLO GIGLIO MOKA 8x33,3
21052 MEDIO BEIGE 33,3x33,3
21141 PROFILO ORO 1x33,3
21833 MODULO GIGLIO MOKA 33,3x33,3

PANNELLI 100,5x201



CK LEATHER RIASSUNTIVO

OGGETTO

CKGRAF3

CODICE

€ 105,00

PREZZO

21791 TORELLO NERO 4x33,3
21051 PELLE MEDIA NERO 33,3x33,3
21876 MOS 64 MODULI ORO 33,3x33,3
21061 PELLE GROSSA NERO 33,3x33,3
N. 6 TOZZETTI PELLE MEDIA
N. 7 TOZZETTI PELLE GROSSA



CK LEATHER CUOIO

OGGETTO

CKGRAF4

CODICE

€ 98,00

PREZZO

21795 TORELLO CUOIO 4x33,3
21052 PELLE MEDIA BEIGE 33,3x33,3
21845 LISTELLO GIGLIO CUOIO 8x33,3
21065 PELLE GROSSA CUOIO 33,3x33,3



CK LEATHER MOKA

OGGETTO

CKGRAF5

CODICE

€ 98,00

PREZZO

21793 TORELLO MOKA 4x33,3
21843 LISTELLO GIGLIO MOKA 8x33,3
21052 MEDIO BEIGE 33,3x33,3
21833 MODULO GIGLIO MOKA 33,3x33,3



CK LEATHER NERO

OGGETTO

CKGRAF6

CODICE

€ 98,00

PREZZO

21791 TORELLO NERO 4x33,3
21050 PELLE MEDIA BIANCO 33,3x33,3
21861 MODULO RIGHE NERO 33,3x33,3



DEPLIANT CRYSTAL KER LUXORING

OGGETTO

6002086

CODICE

€ 2,00

PREZZO

PANNELLI CULLA



NERO/ORO LUCIDO

- 21200 LISTELLO QUADRI ORO 8x33,3
- 21004 LACCATO NERO 33,3x33,3
- 21205 FASCIA ORO 8x33,3
- 21192 MOSAICO 64 MODULI NERO 33,3x33,3



RAMAGE AVORIO

- 21121 TORELLO AVORIO 4x33,3
- 21181 MODULO RAMAGE AVORIO 33,3x33,3
- 21131 MATITA AVORIO 1,5x33,3
- 21001 MADREPERLA AVORIO 33,3x33,3



ORO/AVORIO

- 21133 MATITA ORO 1,5x33,3
- 21171 MODULO QUADRETTI AVORIO 33,3x33,3
- 21123 TORELLO ORO 4,33,3
- 21001 MADREPERLA AVORIO 33,3x33,3



PERLINE NERO

- 21162 LISTELLO PERLINE 1,5x33,3
- 21157 FASCIA PERLINE NERO 8x33,3
- 21004 LACCATO NERO 33,3x33,3 2



QUADRETTI BIANCO

- 21173 LISTELLO QUADRETTI BIANCO 8x33,3
- 21000 MADREPERLA BIANCO 33,3x33,3
- 21142 PROFILO ACCIAIO 0,5x33,3
- 21170 MODULO QUADRETTI BIANCO 33,3x33,3



TOZZETTARIO CK LUXORING

OGGETTO

6000960

CODICE

€ 42,50

PREZZO



CULLA CRYSTAL KER LUXORING

OGGETTO

6001080

CODICE

€ 400,00

PREZZO



22180 BIANCO 33,3x33,3



22181 AVORIO 33,3x33,3



22182 NERO 33,3x33,3



22102 NERO STUOIATO 33,3x33,3

PANNELLI 60x200



CK LUXORING NERO

CK LUXORING BIANCO

CK LUXORING PERLINE

CK LUXORING QUADRETTI

CK LUXORING AVORIO

CK LUXORING BIANCO

OGGETTO

OGGETTO

OGGETTO

OGGETTO

OGGETTO

OGGETTO

CK10001

CK10007

CK10005

CK10004

CK10002

CK10006

CODICE

CODICE

CODICE

CODICE

CODICE

CODICE

€ 98,00

€ 98,00

€ 98,00

€ 98,00

€ 98,00

€ 98,00

PREZZO

PREZZO

PREZZO

PREZZO

PREZZO

PREZZO

21200 FASCIA QUADRI NERO/ORO 8x33,3
21004 LACCATO NERO 33,3x33,3
21205 FASCIA ORO LUCIDO 8x33,3
21192 MOSAICO 64 NERO 33,3x33,3

21183 FASCIA RAMAGE BIANCO 8x33,3
21000 MADREPERLA BIANCO 33,3x33,3
21130 MATITA MADREPERLA BIANCO 1,5x33,3
21180 MODULO RAMAGE BIANCO 33,3x33,3

21157 FASCIA PERLINE NERO 8x33,3
21152 MODULO PERLINE NERO 33,3x33,3
21162 LISTELLO PERLINE NERO 1,5x33,3
21004 LACCATO NERO 33,3x33,3

21133 MATITA ORO 1,5x33,3
21171 MODULO QUADRETTI AVORIO 33,3x33,3
21123 TORELLO ORO 4x33,3
21001 MADREPERLA AVORIO 33,3x33,3

21121 TORELLO AVORIO 4x33,3
21181 MODULO RAMAGE AVORIO 33,3x33,3
21131 MATITA AVORIO 1,5x33,3
21001 MADREPERLA AVORIO 33,3x33,3

21173 FASCIA QUADRI BIANCO 8x33,3
21000 MADREPERLA BIANCO 33,3x33,3
21142 PROFILO ACCIAIO 0,5x33,3
21170 MODULO QUADRETTI MADREPERLA BIANCO 33,3x33,3

PANNELLI 100,5x201



CK LUXORING RIASSUNTIVO

OGGETTO

CKGRAF1/0

CODICE

€ 115,00

PREZZO



CK LUXORING NERO/ORO

OGGETTO

CKGRAF2/0

CODICE

€ 115,00

PREZZO

21121 TORELLO AVORIO 4x33,3
21181 MODULO RAMAGE AVORIO 33,3x33,3
21184 LISTELLO RAMAGE AVORIO 8x33,3
21001 MADREPERLA AVORIO 33,3x33,3
N. 5 TOZZETTI DI CM 10x15
MADREPERLA BIANCO
MADREPERLA AVORIO
LACCATO NERO
ORO
PLATINO

21100 MODULO ORO 33,3x33,3
21200 FASCIA QUADRI NERO/ORO 8x33,3
21004 LACCATO NERO 33,3x33,3
N.1 TOZZETTO PLATINO



DEPLIANT CRYSTAL KER LOFT

OGGETTO

6002121

CODICE

€ 2,00

PREZZO



RASTRELLIERA LOFT

OGGETTO

6007000

CODICE

€ 90,00

PREZZO

**PANNELLI PER ESPOSITORE
SU RICHIESTA**

codice LOGRAF1



CATALOGO E DEPLIANT
CRYSTAL KER WOOD

OGGETTO

Cat. 6002109	Depl. 6002110
CODICE	CODICE
€ 10,40	€ 2,00
PREZZO	PREZZO



ESPOSITORE DA BANCO
CRYSTAL KER WOOD

OGGETTO
6000986
CODICE
€ 40,00
PREZZO

- 23525 PURO GESSO 14,3x50
- 23520 NATURALE SABBIA 14,3x50
- 23521 CHIARO CORDA 14,3x50
- 23523 ANTICO AVANA 14,3x50
- 23522 MEDIO TABACCO 14,3x50
- 23524 FORESTA MOKA 14,3x50

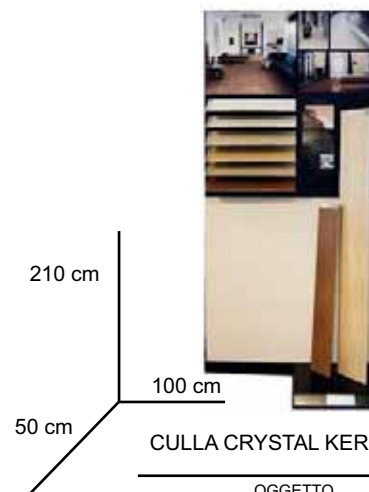

CULLA CRYSTAL KER WOOD

OGGETTO
6001107
CODICE
€ 290,00
PREZZO

- 23525 PURO GESSO 14,3x50
- 23520 NATURALE SABBIA 14,3x50
- 23521 CHIARO CORDA 14,3x50
- 23523 ANTICO AVANA 14,3x50
- 23522 MEDIO TABACCO 14,3x50
- 23524 FORESTA MOKA 14,3x50
- 23526 ANTICO AVANA 14,3x50x53
- 23503 ANTICO AVANA 20x150
- 23514 FORESTA MOKA 14,3x100
- 23531 CHIARO CORDA 100x100

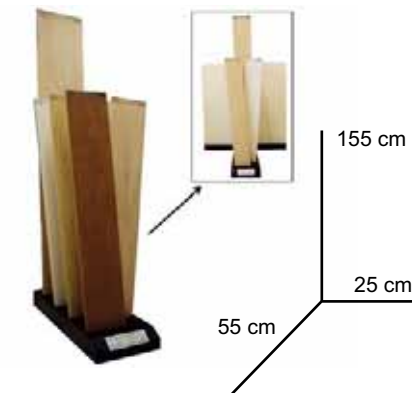

CULLA CRYSTAL KER WOOD

OGGETTO
6001105
CON SCHIENA: 6001106
CODICE
€ 95
€ 125
PREZZO

- 23510 NATURALE SABBIA 14,3x100
- 23511 CHIARO CORDA 14,3x100
- 23512 MEDIO TABACCO 14,3x100
- 23513 ANTICO AVANA 14,3x100
- 23514 FORESTA MOKA 14,3x100
- 23515 PURO GESSO 14,3x100
- 23503 ANTICO AVANA 20x150
- SCHIENA**
- 23531 CHIARO CORDA 100x100



PIEGHEVOLE
CRYSTAL KER WOOD

OGGETTO
6000985
CODICE
€ 17,00
PREZZO



TOZZETTARIO WOOD

OGGETTO
6000979
CODICE
€ 42,50
PREZZO

PANNELLI 60x200



PURO GESSO

OGGETTO

WO10005

CODICE

€ 94,00

PREZZO



NATURALE SABBIA

OGGETTO

WO10000

CODICE

€ 94,00

PREZZO



CHIARO CORDA

OGGETTO

WO10001

CODICE

€ 94,00

PREZZO

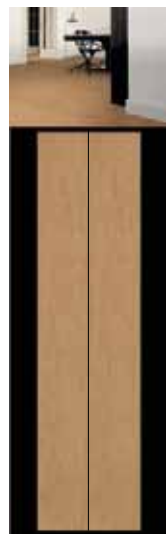

MEDIO TABACCO

OGGETTO

WO10002

CODICE

€ 94,00

PREZZO



ANTICO AVANA

OGGETTO

WO10003

CODICE

€ 94,00

PREZZO



FORESTA MOKA

OGGETTO

WO10004

CODICE

€ 94,00

PREZZO

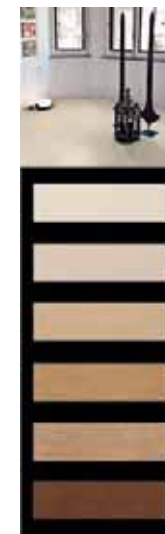

RIASSUNTIVO

OGGETTO

WO10006

CODICE

€ 94,00

PREZZO

23505 PURO GESSO 20x150

23510 NATURALE SABBIA 14,3x100

23521 CHIARO CORDA 14,3x50
23511 CHIARO CORDA 14,3x100

23502 MEDIO TABACCO 20x150

23523 ANTICO AVANA 14,3x50
23513 ANTICO AVANA 14,3x100
23503 ANTICO AVANA 20x150

23524 FORESTA MOKA 14,3x50

23525 PURO GESSO 14,3x50
23520 NATURALE SABBIA 14,3x50
23521 CHIARO CORDA 14,3x50
23522 MEDIO TABACCO 14,3x50
23523 ANTICO AVANA 14,3x50
23524 FORESTA MOKA 14,3x50

SU RICHIESTA GLI STESSI PANNELLI POSSONO ESSERE POSATI IN FORMATO 100,5x201:

WOGRAF0 Sabbia; WOGRAF1 Chiaro Corda; WOGRAF2 Medio Tabacco; WOGRAF3 Antico Avana; WOGRAF4 Foresta Moka; WOGRAF5 Puro Gesso; WOGRAF6 Riassuntivo



CATALOGO DIAMOND

OGGETTO

6002120

CODICE

€ 10,40

PREZZO



DEPLIANT DIAMOND

OGGETTO

6002119

CODICE

€ 2,00

PREZZO



TOZZETTARIO DIAMOND

OGGETTO

6000992

CODICE

€ 39,10

PREZZO

PANNELLI CULLA

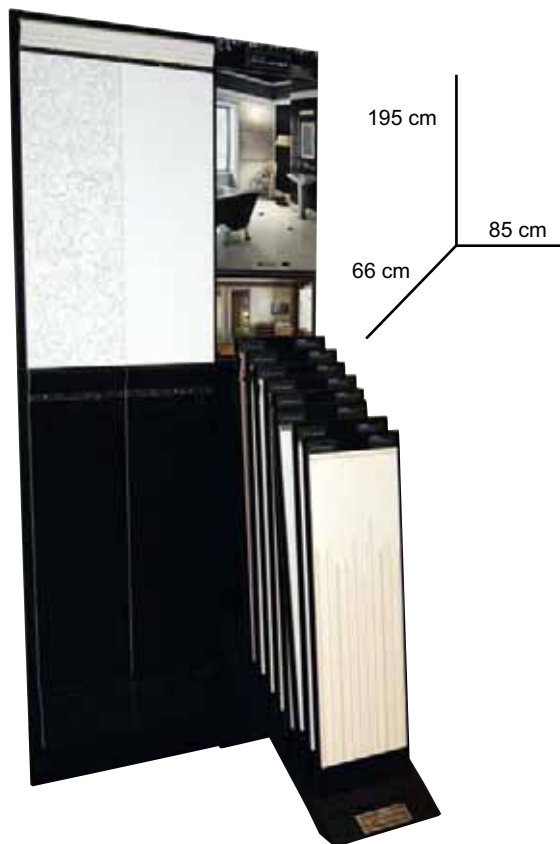

195 cm
85 cm
66 cm



RIEPILOGATIVO

- 17950 BIANCO MARMARA LAP 48x48
- 17633 BEIGE LAP 49x49
- 70020 TOZZETTO DIAMOND GRIGIO 10x10
- 70021 TOZZETTO DIAMOND NERO 10x10
- 70022 TOZZETTO DIAMOND ROSA 10x10
- 70023 TOZZETTO DIAMOND BRONZO 10x10
- 119721 ROVERE NATURALE NAT 13x78,9
- 119724 ROVERE GRIGIO NAT 13x78,9



BIANCO

- 70080 TORELLO BIANCO 6,5x25
- 70010 BOISERIE BIANCO 25x75



GRIGIO

- 70082 TORELLO GRIGIO 6,5x25
- 70012 BOISERIE GRIGIO 25x75



ROSA

- 70084 TORELLO ROSA 6,5x25
- 70576 PROFILO ALLUMINIO BRONZO 1x75
- 70014 BOISERIE ROSA 25x75



CREMA

- 70081 TORELLO CREMA 6,5x25
- 70011 BOISERIE CREMA 25x75

CULLA DIAMOND

OGGETTO

6001120

CODICE

€ 338,00

PREZZO

PANNELLO SCHIENA

- 70080 TORELLO BIANCO 6,5x25
- 70122 MATITA NERO 1,3x25
- 70000 BIANCO 25x75
- 70130 ROMANTIC BIANCO 25x75
- 70083 TORELLO NERO 6,5x25
- 70013 BOISERIE NERO 25x75
- 70063 BATTISCOPA RILIEVO NERO 15x25



BRONZO

- 70085 TORELLO BRONZO 6,5x25
- 70015 BOISERIE BRONZO 25x75



CREMA

- 70121 MATITA GOLD 1,3x25
- 70006 DECOR CREMA 25x75



BIANCO

- 70120 MATITA SILVER 1,3x25
- 70135 PRECIOUS BIANCO 25x75



CREMA

- 70101 MATITA CREMA 1x25
- 70151 TERMINAL ESSENTIAL CREMA 25x75

PANNELLI 60x200



BIANCO

OGGETTO

DI100000

CODICE

€ 100,00

PREZZO

70080 TORELLO BIANCO 6,5x25
70005 BIANCO DECOR 25x75
70120 MATITA SILVER 1,3x25
70010 BOISERIE BIANCO 25x75
70060 BATTISCOPIA BIANCO 15x25



CREMA

OGGETTO

DI10001

CODICE

€ 100,00

PREZZO

70081 TORELLO CREMA 6,5x25
70006 CREMA DECOR 25x75
70121 MATITA GOLD 1,3x25
70011 BOISERIE CREMA 25x75
70061 BATTISCOPIA CREMA 15x25

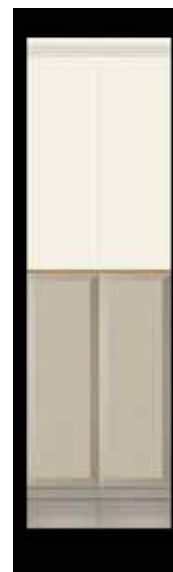

GRIGIO

OGGETTO

DI10002

CODICE

€ 100,00

PREZZO

70081 TORELLO 6,5x25
70001 CREMA 25x75
70121 MATITA GOLD 1,3x25
70012 BOISERIE GRIGIO 25x75
70062 BATTISCOPIA GRIGIO 15x25



NERO

OGGETTO

DI10003

CODICE

€ 100,00

PREZZO

70080 TORELLO BIANCO 6,5x25
70080 BIANCO 25x75
70130 ROMANTIC BIANCO 25x75
70123 MATITA NERO 1,3x25
70013 BOISERIE NERO
70063 BATTISCOPIA NERO 15x25

PANNELLI 60x200

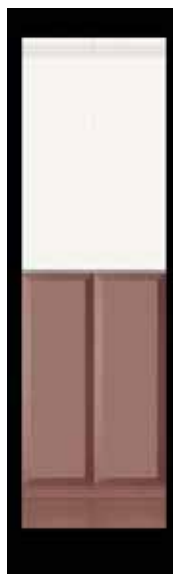

ROSA

OGGETTO

DI10004

CODICE

€ 100,00

PREZZO



BRONZO

OGGETTO

DI10005

CODICE

€ 100,00

PREZZO

70080 TORELLO BIANCO 6,5x25
70000 BIANCO 25x75
70150 TERMINAL ESSENTIAL BIANCO 25x75
70120 MATITA SILVER 1,3x25
70014 BOISERIE ROSA
70064 BATTISCOPA ROSA 15x25

70081 TORELLO CREMA 6,5x25
70001 CREMA 25x75
70136 PRECIOUS CREMA 25x75
70121 MATITA GOLD 1,3x25
70015 BOISERIE BRONZO 25x75
70065 BATTISCOPA BRONZO 15x25

PANNELLI 100,5x201



GRIGIO

OGGETTO

DIGRAF1

CODICE

€ 110,00

PREZZO



NERO

OGGETTO

DIGRAF2

CODICE

€ 110,00

PREZZO



ROSA

OGGETTO

DIGRAF3

CODICE

€ 110,00

PREZZO



BRONZO

OGGETTO

DIGRAF4

CODICE

€ 110,00

PREZZO

70081 TORELLO CREMA 6,5x25
70151 TERMINAL ESSENTIAL 25x75
70001 CREMA 25x75
70121 MATITA GOLD 1,3x25
70012 BOISERIE GRIGIO 25x75
70062 BATTISCOPIA GRIGIO 15x25

PAVIMENTI

119721 ROVERE NAT 13x78,9

70080 TORELLO BIANCO 6,5x25
70122 MATITA NERO 1,3x25
70130 ROMANTIC BIANCO 25x75
70005 DECOR BIANCO 25x75
70120 MATITA SILVER 1,3x25
70013 BOISERIE NERO 25x75
70063 BATTISCOPIA NERO 15x25

PAVIMENTI

17950 BIANCO 48x48

70080 TORELLO BIANCO 6,5x25
70000 BIANCO 25x75
70135 PRECIOUS BIANCO 25x75
70120 MATITA SILVER 1,3x25
70014 BOISERIE ROSA 25x75
70064 BATTISCOPIA ROSA 15x25

PAVIMENTI

17950 BIANCO 48x48

70081 TORELLO CREMA 6,5x25
70001 CREMA 25x75
70136 PRECIOUS CREMA 25x75
70121 MATITA GOLD 1,3x25
70015 BOISERIE BRONZO 25x75
70065 BATTISCOPIA BRONZO 15x25

PAVIMENTI

119721 ROVERE NAT 13x78,9

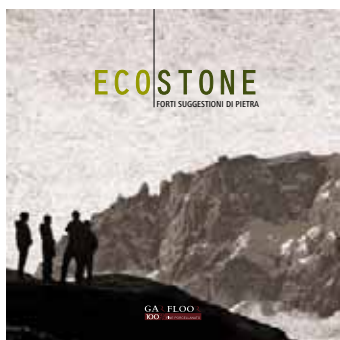

DEPLIANT ECOSTONE

OGGETTO

6002101

CODICE

€ 2,00

PREZZO



TOZZETTARIO ECOSTONE

OGGETTO

6000965

CODICE

€ 39,10

PREZZO

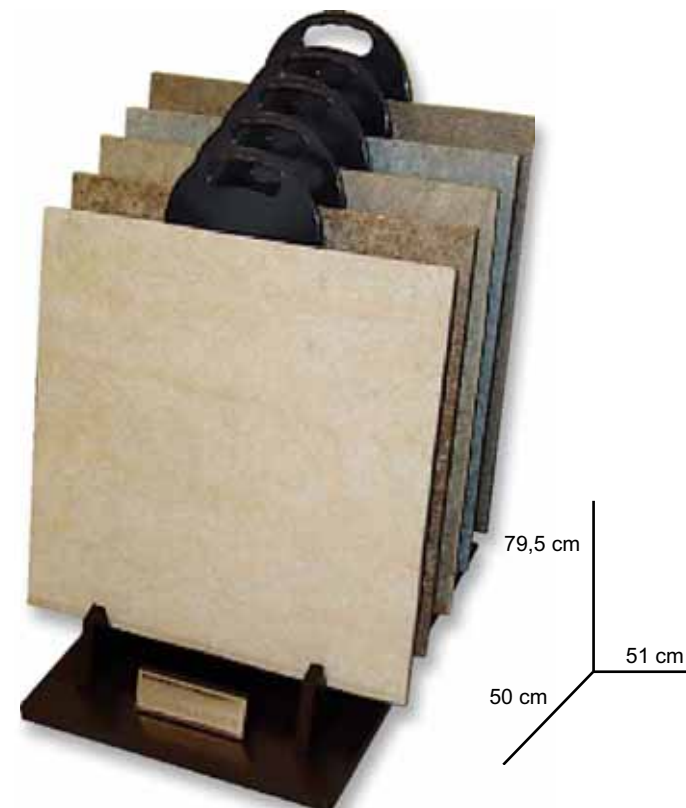

RASTRELLIERA ECOSTONE

OGGETTO

6001100

CODICE

€ 51,00

PREZZO

26570 BEIGE 50x50
26571 GRIGIO 50x50
26572 VERDE 50x50
26573 ROSSO 50x50
26574 NERO 50x50

PANNELLI CULLA

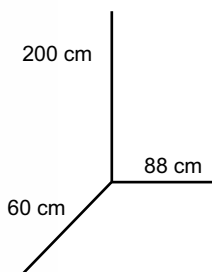

ROSSO

26503 ROSSO 33,3x33,3
26513 ROSSO 16,5x33,3



GRIGIO

26551 MOSAICO PREINCISO GRIGIO 33,3x33,3
26501 GRIGIO 33,3x33,3



VERDE

26532 FASCIA VERDE 16,5x33,3
26502 VERDE 33,3x33,3
26512 VERDE 16,5x33,3



NERO

26514 NERO 16,5x33,3



BEIGE

26500 BEIGE 33,3x33,3

CULLA ECOSTONE

OGGETTO

6001097

CODICE

€ 360,00

PREZZO

PANNELLI 100,5x201 - 120,5x201

Beige
ECGRAF0

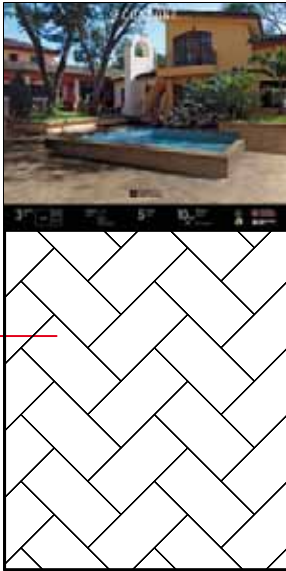

26510 beige
16,5x33,3

€ 88,00

Rosso
ECGRAF3



26503 rosso
33,3x33,3

26513 rosso
16,5x33,3

€ 88,00

Grigio
ECGRAF1



26501 grigio
33,3x33,3

26551 mosaico
grigio 33,3x33,3

€ 88,00

Nero
ECGRAF4

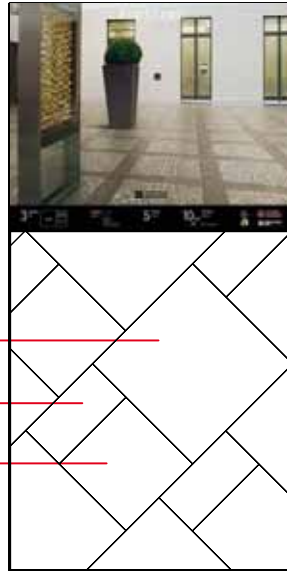

26574 nero
50x50

26504 nero
33,3x33,3

26514 nero
16,5x33,3

€ 88,00

Verde
ECGRAF2



26502 verde
33,3x33,3

26512 verde
16,5x33,3

26532 fascia
verde 16,5x33,3

€ 88,00

RIASSUNTIVO
ECGRAF5



26502 VERDE 33,3x33,3
26512 VERDE 16,5x33,3
26572 VERDE 50x50

TOZZETTI COLORE:

BEIGE
ROSSO
VERDE
GRIGIO
NERO

€ 88,00



DEPLIANT INFINITY STONE

OGGETTO

6002078

CODICE

€ 2,00

PREZZO



TOZZETTARIO INFINITY STONE

OGGETTO

6000954

CODICE

€ 39,10

PREZZO



RASTRELLIERA INFINITY STONE

OGGETTO

Indicare: 1 codice rastrelliera +
1 codice materiale
(vedi rastrelliere pag. 10)

CODICE

€ 258,00 (culla lineare Infinity)
€ 308,00 (culla in salita Infinity)

PREZZO



ESEMPIO:

RASTRELLIERA
GRANDI FORMATI IN SALITA +
7pz INFINITY STONE 60x90

COD 6001090 + COD 6001111

€ 308,00



PANNELLO INFINITY WENGE'
cm 200x256

OGGETTO

INF0001

CODICE

€ 750,00

PREZZO

PANNELLI 100,5x201 - 120,5x201

SCHEMA A
IN00002/A

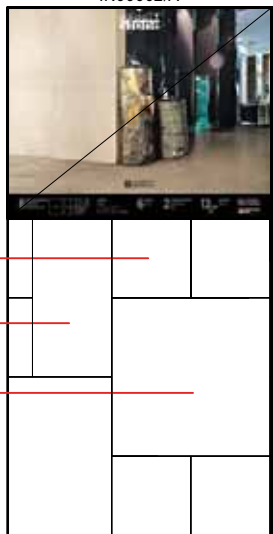

fondo 30x30
fondo 30x60
fondo 60x60

€ 110,00

SCHEMA B
IN00002/B

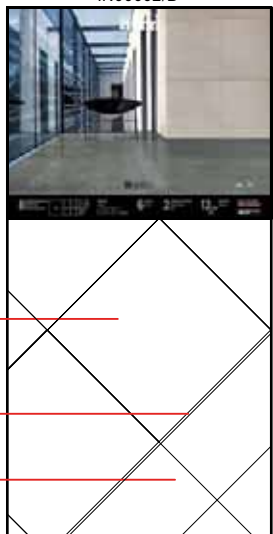

fondo 60x60
profilo 1x60
fondo 30x30

€ 110,00

SCHEMA C
IN00002/C



fondo 30x60
profilo 1x60
fondo 30x30

€ 110,00

RIASSUNTIVO
INGRAF5



26030 BIANCO LAPPATO 60x120

TOZZETTI COLORE:

BIANCO NAT E LAP
GRIGIO NAT E LAP
NERO NAT E LAP
BEIGE NAT E LAP
NOCE NAT E LAP
PORFIDO NAT E LAP
MOKA NAT E LAP

€ 110,00

SCHEMA D
IN00002/D



fondo 60x60
fondo 60x120

€ 110,00

SCHEMA F
IN00002/F



fondo 30x120
fondo 60x120

€ 110,00

SCHEMA H
IN00002/H



120x120

€ 110,00

PER OGNI SCHEMA DI POSA SCELTO È NECESSARIO INDICARE NEL COMMENTO IL COLORE E LA SUPERFICIE (NAT O LAP) CHE SI VUOLE POSARE. LA FOTO VIENE APPLICATA DI CONSEGUENZA.

GLI SCHEMI D-F-H SONO SOLO PER PANNELLI 120,5x201



DEPLIANT KARMA

OGGETTO

6002083

CODICE

€ 2,00

PREZZO



CULLA KARMA

OGGETTO

6001086

CODICE

€ 280,00

PREZZO

PANNELLI CULLA



MOKA

- 67001 AVORIO 25x60
- 67135 LISTELLO OPTICAL MOKA 3x60
- 67125 FASCIA OPTICAL MOKA 7,8x60
- 67005 MOKA



BEIGE

- 67033 TORELLO BEIGE 4x60
- 67091 FASCIA FIORI AVORIO/BEIGE 7,8x60
- 67001 AVORIO 25x60
- 67101 LISTELLO FIORI AVORIO/BEIGE 3x60
- 67081 MODULO FIORI AVORIO/BEIGE 25x60
- 67003 BEIGE 25x60



BIANCO

- 67000 BIANCO 25x60
- 67120 FASCIA OPTICAL BIANCO 7,8x60
- 67160 PROFILO METALLO ALLUMINIO
- 67110 MODULO OPTICAL BIANCO 25x60
- 67002 GRIGIO 25x60



NERO

- 67000 BIANCO 25x60
- 67064 FASCIA TEXTURE NERO 7,8x60
- 67074 LISTELLO TEXTURE NERO 3x60
- 67144 MODULO PREINCISO NERO 25x60



MOKA

- 14282 MOKA 41x41
- 14342 MOSAICO MOKA 41x41



BEIGE

- 14280 BEIGE 41x41

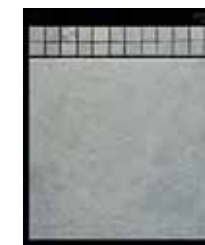

BIANCO

- 14281 GRIGIO 41x41
- 14341 MOSAICO GRIGIO 41x41



NERO

- 14283 NERO 41x41
- 14463 FASCIA NERO 3,5x41

PANNELLI 60x200



AVORIO/BEIGE

OGGETTO

KA10004

CODICE

€ 94,00

PREZZO

67033 TORELLO BEIGE 4x60
67091 FASCIA FIORI AVORIO/BEIGE 7,8x60
67001 AVORIO 25x60
67101 LISTELLO FIORI AVORIO/BEIGE 3x60
67081 MODULO FIORI AVORIO/BEIGE 25x60
67003 BEIGE 25x60



BIANCO/GRIGIO

OGGETTO

KA10002

CODICE

€ 94,00

PREZZO

67000 BIANCO 25x60
67120 FASCIA OPTICAL BIANCO 7,8x60
67160 PROFILO METALLO ALLUMINIO 0,5x60
67110 MODULO OPTICAL BIANCO 25x60
67002 GRIGIO 25x60



AVORIO/MOKA

OGGETTO

KA10001

CODICE

€ 94,00

PREZZO

67001 AVORIO 25x60
67135 LISTELLO OPTICAL MOKA 3x60
67125 FASCIA OPTICAL MOKA 7,8x60
67005 MOKA 25x60



BIANCO/NERO

OGGETTO

KA10003

CODICE

€ 94,00

PREZZO

67000 BIANCO 25x60
67064 FASCIA NERO 7,8x60
67074 LISTELLO NERO 3x60
67144 MODULO PREINCISO NERO 25x60

PANNELLI 100,5x201



AVORIO/BEIGE

OGGETTO

KAGRAF2

CODICE

€ 94,00

PREZZO

67033 TORELLO BEIGE 4x60
67091 FASCIA FLOREALE 7,8x60
67001 AVORIO 25x60
67081 MODULO FLOREALE 25x60
67101 LISTELLO FLOREALE 3x60
67003 BEIGE 25x60

PAVIMENTI
14280 BEIGE 41x41

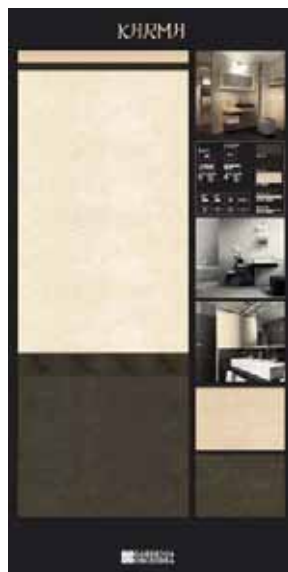

AVORIO/MOKA

OGGETTO

KAGRAF5

CODICE

€ 94,00

PREZZO

67001 AVORIO 25x60
67135 LISTELLO OPTICAL 3x60
67161 PROFILO BRONZO 0,5x60
67125 FASCIA OPTICAL 7,8x60
67005 MOKA 25x60

PAVIMENTI
14280 BEIGE 41x41
14282 MOKA 41x41



BIANCO/GRIGIO

OGGETTO

KAGRAF6

CODICE

€ 94,00

PREZZO

67032 TORELLO GRIGIO 4x60
67120 FASCIA OPTICAL 7,8x60
67000 BIANCO 25x60
67160 PROFILO ALLUMINIO 0,5x60
67110 MODULO OPTICAL 25x60
67002 GRIGIO 25x60

PAVIMENTI
14281 GRIGIO 41x41



BIANCO/NERO

OGGETTO

KAGRAF3

CODICE

€ 94,00

PREZZO

67000 BIANCO 25x60
67064 FASCIA TEXTURE 7,8x60
67160 PROFILO ALLUMINIO 0,5x60
67074 FASCIA TEXTURE 3x60
67144 MOSAICO PREINCISO NERO 25x60

PAVIMENTI
14283 NERO 41x41

Beige/Moka
KA00001

14280 beige 41x41

14340 mosaico beige 41x41

14282 moka 41x41

€ 92,00

Grigio/Nero
KA00002

14281 grigio 41x41

14343 mosaico nero 41x41

14283 nero 41x41

€ 92,00



DEPLIANT LE FILIGRANE

OGGETTO

6002102

CODICE

€ 2,00

PREZZO

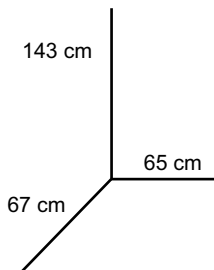

CULLA LE FILIGRANE

OGGETTO

6001098

CODICE

€ 260,00

PREZZO

PANNELLI CULLA



AVORIO/MOKA

- 66502 AVORIO 25x60
- 66562 LISTELLO AVORIO 2,5x60
- 66523 MATITA MOKA 1x60
- 66563 LISTELLO MOKA 2,5x60
- 66503 MOKA 25x60



BIANCO/ANTRACITE

- 66510 TORELLO BIANCO 4x60
- 66561 LISTELLO ANTRACITE 2,5x60
- 66500 BIANCO 25x60
- 66571 LISTELLO QUADRI ANTRACITE 7,8x60
- 66501 ANTRACITE 25x60

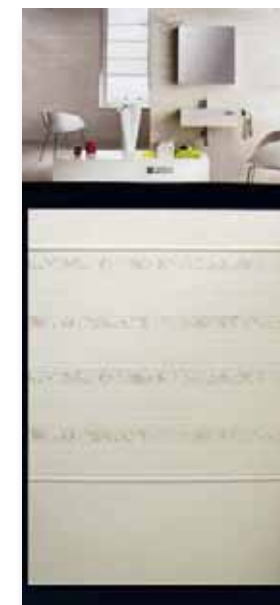

BIANCO

- 66500 BIANCO 25x60
- 66520 MATITA BIANCA 1x60
- 66530 DAMASCO INCISO BIANCO 25x60



14422 BIANCO 41x41



14423 AVORIO 41x41

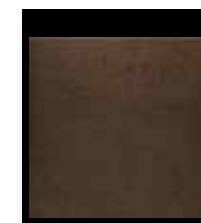

14421 MOKA 41x41



14420 ANTRACITE 41x41

PANNELLI 60x200



BIANCO

OGGETTO

FI10003

CODICE

€ 90,00

PREZZO

66500 BIANCO 25x60
66520 MATITA BIANCA 1x60
66530 DAMASCO INCISO BIANCO 25x60



AVORIO/MOKA

OGGETTO

FI10002

CODICE

€ 90,00

PREZZO

66502 AVORIO 25x60
66562 LISTELLO AVORIO 2,5x60
66523 MATITA MOKA 1x60
66563 LISTELLO MOKA 2,5x60
66503 MOKA 25x60



BIANCO/ANTRACITE

OGGETTO

FI10001

CODICE

€ 90,00

PREZZO

66510 TORELLO BIANCO 4x60
66561 LISTELLO ANTRACITE 2,5x60
66500 BIANCO 25x60
66571 LISTELLO QUADRI ANTRACITE 7,8x60
66501 ANTRACITE 25x60

PANNELLI RIVESTIMENTI 100,5x201 / PANNELLI PAVIMENTI 100,5x201 - 120,5x201



AVORIO/MOKA

OGGETTO

FIGRAF2

CODICE

€ 90,00

PREZZO



BIANCO/ANTRACITE

OGGETTO

FIGRAF1

CODICE

€ 90,00

PREZZO

66512 TORELLO AVORIO 4x60
66562 LISTELLO AVORIO 2,5x60
66502 AVORIO 25x60
66523 MATITA MOKA 1x60
66563 LISTELLO MOKA 2,5x60
66503 MOKA 25x60

PAVIMENTI

14423 BEIGE 41x41
14421 MOKA 41x41

66510 TORELLO BIANCO 4x60
66560 LISTELLO BIANCO 2,5x60
66500 BIANCO 25x60
66571 LISTELLO QUADRO ANTRACITE 7,8x60
66501 ANTRACITE 25x60

PAVIMENTI

14422 BIANCO 41x41
14420 ANTRACITE 41x41

Bianco/Antracite
FIGRAF5

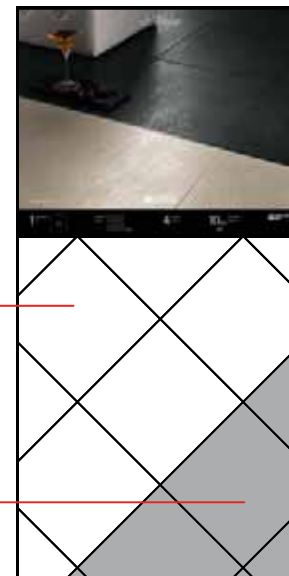

14422 bianco
41x41

14420 antracite
41x41

€ 88,00

Beige/Moka
FIGRAF4

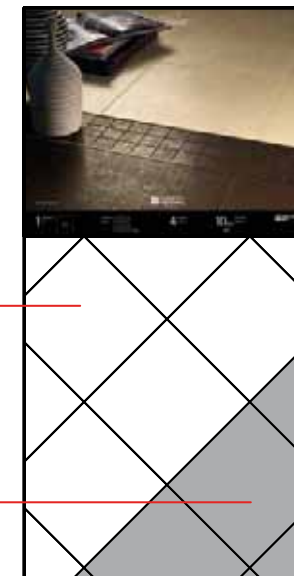

14423 avorio
41x41

14421 moka
41x41

€ 88,00

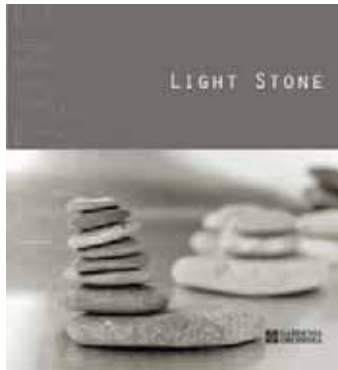

DEPLIANT LIGHT STONE

OGGETTO

6002108

CODICE

€ 2,00

PREZZO



TOZZETTARIO LIGHT STONE

OGGETTO

6000969

CODICE

€ 39,10

PREZZO



136 cm

68 cm

78 cm

CULLA LIGHT STONE

OGGETTO

6001103

CODICE

€ 194,00

PREZZO

PANNELLI CULLA

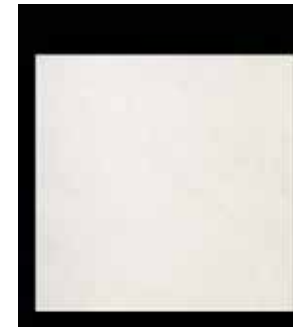

17560 BIANCO 60x60



17561 BEIGE 60x60



17562 GRIGIO 60x60



17563 NERO 60x60



17564 NOCE 60x60
17579 MOSAICO NOCE 30x30

PANNELLI 100,5x201 - 120,5x201

Bianco/Nero
LSGRAF1

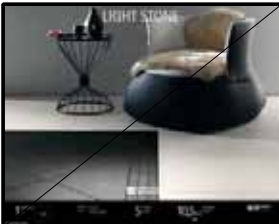
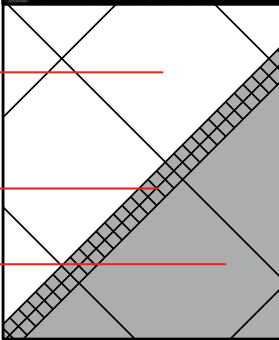
17560 bianco
60x60

17578 mosaico
nero 30x30

17563 nero
60x60

€ 88,00

Grigio
LSGRAF2

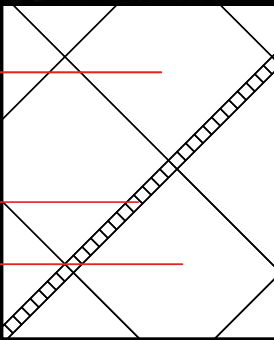
17562 grigio
60x60

17577 mosaico
grigio 30x30

17562 grigio
60x60

€ 88,00

Beige/Noce
LSGRAF3

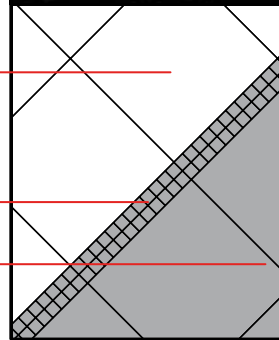
17561 beige
beige 60x60

17572 mosaico
noce 30x30

17564 noce
60x60

€ 88,00



DEPLIANT/CATALOGO LIRICA

OGGETTO

CAT 6002106 DEPL. 6002103

CODICE

CAT € 10,40 DEPL. € 2,00

PREZZO

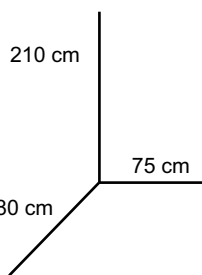

CULLA LIRICA RIV

OGGETTO

6001109

CODICE

€ 370,00

PREZZO

PANNELLI CULLA

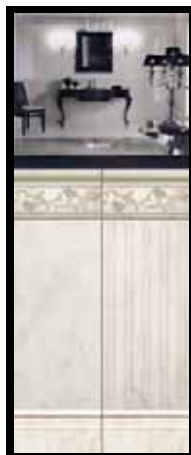

BIANCO

- 67390 TORELLO CLASSIC BIANCO 5x25
- 67330 LISTELLO FLOREALE BIANCO 9,5x25
- 67450 MATITA BIANCO 1x60
- 67250 BIANCO MARMARA 25x60
- 67310 MODULO RIGA BIANCO 25x60
- 67370 FASCIA RILIEVO BIANCO 15x25



BIANCO/GRIGIO

- 67430 TORELLO MODERNO BIANCO 4x60
- 67325 LISTELLO TIFFANY BIANCO/PLATINO 3x60
- 67250 BIANCO MARMARA 25x60
- 67160 PROFILO ALLUMINIO ARGENTO 0,5x60
- 67320 LISTELLO DAMASCO GRIGIO 12x60
- 67252 GRIGIO BALCAN 25x60

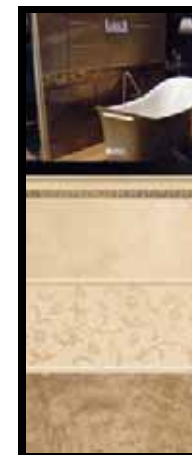

NOCE/CREMA

- 67431 TORELLO MODERNO CREMA 4x60
- 67326 LISTELLO TIFFANY NOCE/ORO 3x60
- 67251 CREMA MARFIL 25x60
- 67451 MATITA CREMA 1x60
- 67306 DECORO FLOREALE CREMA 25x60
- 67253 NOCE EMPERADOR 25x60



67280
MOSAICO BIANCO/GRIGIO
25x60



ROSA

- 67394 TORELLO CLASSIC ROSA 5x25
- 67342 LISTELLO RILIEVO ROSA 5x25
- 67282 MOSAICO ROSA 25x60
- 67254 ROSA PORTOGALLO 25x60
- 67374 FASCIA RILIEVO ROSA 15x25



TRAVERTINO CHIARO

- 67435 TORELLO MODERNO TRAV. CHIARO 4x60
- 67326 LISTELLO TIFFANY NOCE/ORO 3x60
- 67455 MATITA TRAVERTINO CHIARO 1x60
- 67303 BOISERIE CLASSIC TRAVERTINO 25x60
- 67255 TRAVERTINO CHIARO 25x60
- 67375 FASCIA RILIEVO TRAV. CHIARO 15x25



TRAVERTINO CHIARO/SCURO

- 67338 LISTELLO RILIEVO TRAV. 9,5x25
- 67343 LISTELLO RILIEVO TRAV. 5x25
- 67255 TRAVERTINO CHIARO 25x60
- 67256 TRAVERTINO SCURO 25x60
- 67375 FASCIA RILIEVO TRAV. CHIARO 15x25
- 67376 FASCIA RILIEVO TRAV. SCURO 15x25



67281
MOSAICO CREMA/NOCE
25x60

PANNELLI CULLA

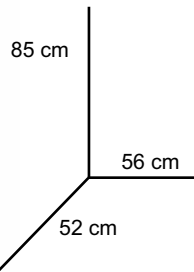

CULLA LIRICA PAV

OGGETTO

6001104 (NAT) 6001095 (LAP)

CODICE

€ 105,00

PREZZO

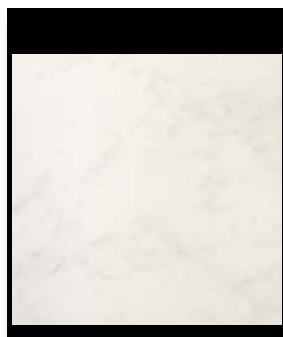

17040 BIANCO NAT 50x50
17950 BIANCO LAP 48x48



17042 GRIGIO NAT 50x50
17952 GRIGIO LAP 48x48



17044 ROSA NAT 50x50
17954 ROSA LAP 48x48



17041 CREMA NAT 50x50
17951 CREMA LAP 48x48

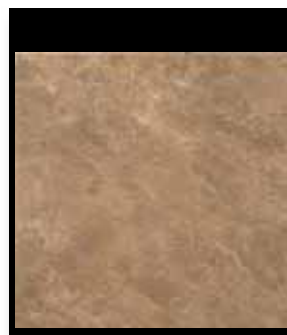

17043 NOCE NAT 50x50
17953 NOCE LAP 48x48



17045 TRAV. CHIARO NAT 50x50
17955 TRAV. CHIARO LAP 48x48



17046 TRAV. SCURO NAT 50x50
17956 TRAV. SCURO LAP 48x48

PANNELLI 60x200



BIANCO

OGGETTO

LI10001

CODICE

€ 100,00

PREZZO



BIANCO/GRIGIO

OGGETTO

LI10002

CODICE

€ 100,00

PREZZO



CREMA/NOCE

OGGETTO

LI10003

CODICE

€ 100,00

PREZZO



ROSA

OGGETTO

LI10004

CODICE

€ 100,00

PREZZO



TRAVERTINO CHIARO

OGGETTO

LI10005

CODICE

€ 100,00

PREZZO

TRAVERTINO
CHIARO/SCURO

OGGETTO

LI10006

CODICE

€ 100,00

PREZZO

67390 TORELLO BIANCO 5x25
67330 LIST FLOREALE BIANCO 9,5x25
67450 MATITA BIANCO 1x60
67250 BIANCO MARMARA 25x60
67310 MODULO RIGA BIANCO 25x60
67370 FASCIA RILIEVO BIANCO 15x25

67430 TORELLO MODERNO BIANCO
4x60
67325 LISTELLO TIFFANY BIANCO/
PLATINO 3x60
67250 BIANCO M. 25x60
67160 PROFILO ARGENTO 0,5x60
67320 LISTELLO DAMASCO GRIGIO/
PLATINO 12x60
67252 GRIGIO BALCAN 25x60

67431 TORELLO MODERNO CREMA
4x60
67326 LISTELLO TIFFANY NOCE/ORO
3x60
67251 CREMA MARFIL 25x60
67451 MATITA CREMA 1x60
67306 DECORO FLOREALE CREMA
25x60
67253 NOCE EMPERADOR 25x60

67394 TORELLO ROSA 5x25
67342 LIST RILIEVO ROSA 5x25
67282 MOSAICO ROSA 25x60
67254 ROSA PORTOGALLO 25x60

67435 TORELLO MODERNO
TRAVERTINO CHIARO 4x60
67326 LISTELLO TIFFANY NOCE/ORO
3x60
67455 MATITA TRAVERTINO CHIARO
1x60
67303 BOISERIE CLASSIC
TRAVERTINO 25x60
67255 TRAVERTINO CHIARO 25x60

67338 LISTELLO RILIEVO TRAVERTINO
9,5x25
67343 LISTELLO RILIEVO TRAVERTINO
5x25
67255 TRAVERTINO CHIARO 25x60
67256 TRAVERTINO SCURO 25x60
67376 FASCIA RILIEVO TRAVERTINO
SCURO 5x25

PANNELLI 100,5x201



BIANCO

OGGETTO

LIGRAF1

CODICE

€ 100,00

PREZZO



BIANCO/GRIGIO

OGGETTO

LIGRAF2

CODICE

€ 100,00

PREZZO



CREMA/NOCE

OGGETTO

LIGRAF3

CODICE

€ 100,00

PREZZO



ROSA

OGGETTO

LIGRAF4

CODICE

€ 100,00

PREZZO



**TRAVERTINO
CHIARO/SCURO**

OGGETTO

LIGRAF5

CODICE

€ 100,00

PREZZO

67370 FASCIA RILIEVO 15x25
67250 BIANCO MARMARA 25x60
37390 TORELLO BIANCO 5x25
67330 LISTELLO FLOREALE 9,5x25
67410 MATITA BIANCA 1x25
67310 MODULO RIGA 25x60

PAVIMENTI

17950 BIANCO LAP 48x48
17952 GRIGIO LAP 48x48

67430 TORELLO MODERNO 4x60
67325 LISTELLO TIFFANY 3x60
67250 BIANCO MARMARA 25x60
67160 PROFILO ALLUMINIO 0,5x60
67320 LISTELLO DAMASCO 12x60
67252 GRIGIO BALCAN 25x60

PAVIMENTI

17950 BIANCO LAP 48x48
17952 GRIGIO LAP 48x48

67431 TORELLO MODERNO 4x60
67326 LISTELLO TIFFANY 3x60
67251 CREMA MARFIL 25x60
67451 MATITA CREMA 1x60
67306 DECORO FLOREALE 25x60
67253 NOCE EMPERADOR 25x60

PAVIMENTI

17951 CREMA MARFIL LAP 48x48
17953 NOCE EMPERADOR LAP 48x48

67374 FASCIA RILIEVO 15x25
67254 ROSA PORTOGALLO 25x60
67337 LISTELLO RILIEVO 9,5x25
67282 MOSAICO ROSA 25x60

PAVIMENTI

17954 ROSA PORTOGALLO LAP 48x48

67343 LISTELLO RILIEVO 5x25
67161 PROFILO BRONZO 0,5x60
67255 TRAVERTINO CHIARO 25x60
67338 LISTELLO TRAVERTINO 9,5x25
67256 TRAVERTINO SCURO 25x60
67376 FASCIA RILIEVO 15x25

PAVIMENTI

17955 TRAVERTINO CHIARO LAP 48x48
17956 TRAVERTINO SCURO LAP 48x48

PANNELLI 100,5x201



BEIGE

OGGETTO

LUGRA20

CODICE

€ 100,00

PREZZO

POSA 1)
85075 DECORO CASSIOPEA 32,5x97,7
85020 T.U. BEIGE 32,5x97,7

POSA 2)
85085 DECORO PEGASO 32,5x97,7
85020 T.U. BEIGE 32,5x97,7

POSA 3)
85077 CASSIOPEA BEIGE 32,5x97,7
85015 BASALTO BEIGE 32,5x97,7

PAVIMENTI
62204 BEIGE 33,3x33,3



BIANCO/NERO

OGGETTO

LUGRA22

CODICE

€ 100,00

PREZZO

POSA 1)
85270 MODULO FLOREALE BIANCO 32,5x32,5
85255 NERO 32,5x97,7

POSA 2)
85250 BIANCO 32,5x97,7
85255 NERO 32,5x97,7

POSA 3)
85250 BIANCO 32,5x97,7
85301 CASSIOPEA GOLD 32,5x97,7

PAVIMENTI
62202 NERO 33,3x33,3
62200 BIANCO 33,3x33,3

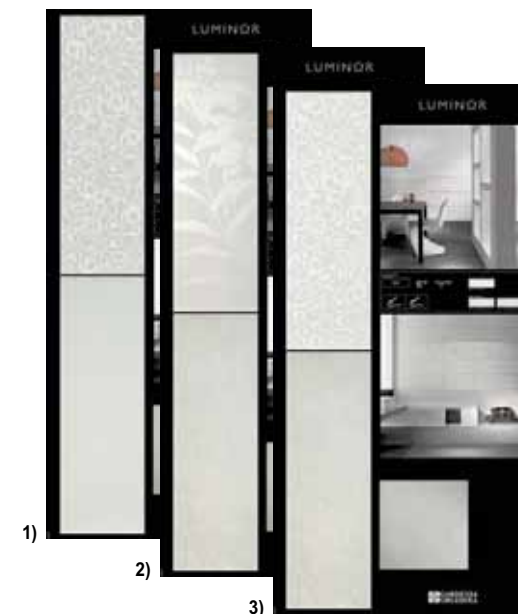

GRIGIO

OGGETTO

LUGRA23

CODICE

€ 100,00

PREZZO

POSA 1)
85076 DECORO CASSIOPEA 32,5x97,7
85000 BASALTO GRIGIO 32,5x97,7

POSA 2)
85086 DECORO PEGASO 32,5x97,7
85000 BASALTO GRIGIO 32,5x97,7

POSA 3)
85078 CASSIOPEA GRIGIO 32,5x97,7
85005 T.U. GRIGIO 32,5x97,7

PAVIMENTI
62201 GRIGIO 33,3x33,3

PANNELLI 60x200 SU RICHIESTA

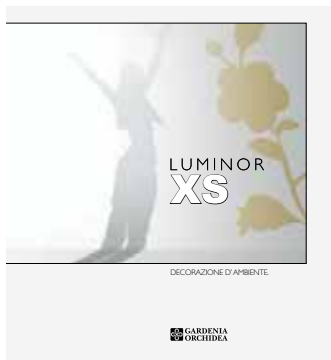

DEPLIANT LUMINOR XS

OGGETTO

6002076

CODICE

€ 2,00

PREZZO

PANNELLI CULLA



BIANCO/NERO

- 62107 LISTELLO NEOBAROCCO BIANCO 6,2x50
- 62008 BIANCO 20x50
- 62112 LISTELLO NEOBAROCCO BIANCO 2,5x50
- 62009 NERO 20x50



BEIGE

- 62111 LISTELLO NEOBAROCCO BEIGE 2,5x50
- 62005 T.U. BEIGE 20x50
- 62073 DECORO CASSIOPEA T.U. BEIGE 20x50
- 61042 PROFILO METALLO BRONZO 1x50
- 62004 BASALTO BEIGE 20x50



GRIGIO/ANTRACITE

- 62110 LISTELLO NEOBAROCCO GRIGIO 2,5x50
- 62000 BASALTO GRIGIO 20x50
- 62105 LISTELLO NEOBAROCCO GRIGIO 6,2x50
- 62002 GRANIGLIATO ANTRACITE 20x50



BEIGE/NOCE

- 62106 LISTELLO NEOBAROCCO BEIGE 6,2x50
- 62004 BASALTO BEIGE 20x50
- 62096 MODULO METAL NEOBAROCCO BEIGE 20x50
- 62111 LISTELLO NEOBAROCCO BEIGE 2,5x50
- 62006 GRANIGLIATO MOKA 20x50



GRIGIO/ANTRACITE

- 62110 LISTELLO NEOBAROCCO GRIGIO 2,5x50
- 62001 T.U. GRIGIO 20x50
- 62075 LISTELLO CASSIOPEA T.U. GRIGIO 6,2x50
- 62000 BASALTO GRIGIO 20x50

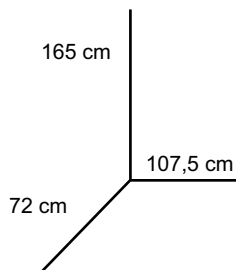

CULLA LUMINOR XS

OGGETTO

6001072

CODICE

€ 300,00

PREZZO



62200 BIANCO 33,3x33,3



62201 GRIGIO 33,3x33,3



62202 NERO 33,3x33,3

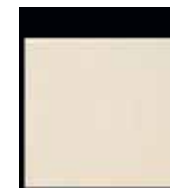

62203 AVORIO 33,3x33,3



62204 BEIGE 33,3x33,3



62205 MOKA 33,3x33,3

PANNELLI 60x200



BEIGE/NOCE

OGGETTO

LUXS102

CODICE

€ 92,00

PREZZO



BEIGE/MOKA

OGGETTO

LUXS103

CODICE

€ 92,00

PREZZO



BIANCO/NERO

OGGETTO

LUXS101

CODICE

€ 92,00

PREZZO



GRIGIO/ANTRACITE

OGGETTO

LUXS105

CODICE

€ 92,00

PREZZO



GRIGIO

OGGETTO

LUXS104

CODICE

€ 92,00

PREZZO

62111 LISTELLO NEOBAROCCO BEIGE
6,2x50
62005 T.U. BEIGE 20x50
62073 DECORO CASSIOPEA 20x50
62004 BASALTO BEIGE 20x50
61046 PROFILO BRONZO 0,5x50

62106 LISTELLO NEOBAROCCO BEIGE
6,2x50
62004 BASALTO BEIGE 20x50
62096 MODULO NEOBAROCCO BEIGE
20x50
62111 LISTELLO NEOBAROCCO BEIGE
2,5x50
62006 GRANIGLIATO MOKA 20x50

62107 LISTELLO NEOBAROCCO BIANCO
6,2x50
62008 T.U. BIANCO 20x50
62112 LISTELLO NEOBAROCCO NERO
2,5x50
62009 NERO PL 20x50

62110 LISTELLO NEOBAROCCO GRIGIO
2,5x50
62001 T.U. GRIGIO 20x50
62105 LISTELLO NEOBAROCCO GRIGIO
6,2x50
62003 LEGNO ANTRACITE 20x50

62110 LISTELLO NEOBAROCCO GRIGIO
2,5x50
62001 T.U. GRIGIO 20x50
62045 PROFILO ARGENTO 0,5x50
62071 MODULO CASSIOPEA 20x50
62075 LISTELLO CASSIOPEA GRIGIO 6,2x50
62000 BASALTO GRIGIO 20x50

PANNELLI 100,5x201



BEIGE/MOKA

OGGETTO

LUXSGR1

CODICE

€ 92,00

PREZZO



BEIGE

OGGETTO

LUXSGR2

CODICE

€ 92,00

PREZZO



GRIGIO

OGGETTO

LUXSGR3

CODICE

€ 92,00

PREZZO



GRIGIO

OGGETTO

LUXSGR6

CODICE

€ 92,00

PREZZO



BIANCO/NERO

OGGETTO

LUXSGR4

CODICE

€ 92,00

PREZZO

62106 LISTELLO NEOBAROCCO 6,2x50
62004 BASALTO BEIGE 20x50
61046 PROFILO BRONZO 0,5x50
62096 MODULO NEOBAROCCO 20x50
62111 LISTELLO NEOBAROCCO 2,5x50
62006 GRANIGLIATO MOKA 20x50

PAVIMENTI

62204 BEIGE 33,3x33,3

62034 TORELLO BEIGE 4x50
62005 T.U. BEIGE 20x50
62054 MATITA BEIGE 1x50
62073 DECORO CASSIOPEA 20x50
62111 LISTELLO NEOBAROCCO 2,5x50
62004 BASALTO BEIGE 20x50

PAVIMENTI

62203 AVORIO 33,3x33,3
62205 MOKA 33,3x33,3

62030 TORELLO BASALTO GRIGIO 4x50
62105 LISTELLO NEOBAROCCO 6,5x50
62000 BASALTO GRIGIO 20x50
61045 PROFILO ARGENTO 0,5x50
62095 MODULO NEOBAROCCO 20x50
62110 LISTELLO NEOBAROCCO 2,5x50
62000 BASALTO GRIGIO 20x50

PAVIMENTI

62201 QUARZO GRIGIO 33,3x33,3

62031 TORELLO T.U. GRIGIO 4x50
62001 T.U. GRIGIO 20x50
62051 MATITA GRIGIA 1x50
62071 DECORO CASSIOPEA 20x50
62110 LISTELLO NEOBAROCCO 2,5x50
62000 BASALTO GRIGIO 20x50

PAVIMENTI

62201 QUARZO GRIGIO 33,3x33,3

62038 TORELLO BIANCO 4x50
62077 LISTELLO CASSIOPEA 6,2x50
62008 T.U. BIANCO 20x50
62112 LISTELLO NEOBAROCCO 2,5x50
62009 NERO PL 20x50

PAVIMENTI

62200 DIAMANTE BIANCO 33,3x33,3
62202 NERO PERLA 33,3x33,3



CATALOGO NATURAL

OGGETTO

6002117

CODICE

€ 10,40

PREZZO



DEPLIANT NATURAL

OGGETTO

6002118

CODICE

€ 2,00

PREZZO



TOZZETTARIO NATURAL

OGGETTO

6000987

CODICE

€ 39,10

PREZZO



RASTRELLIERA NATURAL

OGGETTO

Indicare: 1 codice rastrelliera +
1 codice materiale
(vedi rastrelliere pag. 10)

CODICE

€ 168,00 (culla *lineare* Natural)
€ 218,00 (culla *in salita* Natural)

PREZZO



ESEMPIO:

RASTRELLIERA
GRANDI FORMATI IN SALITA +
6pz NATURAL 78,9x78,9

COD 6001090 + COD 6001118

€ 218,00

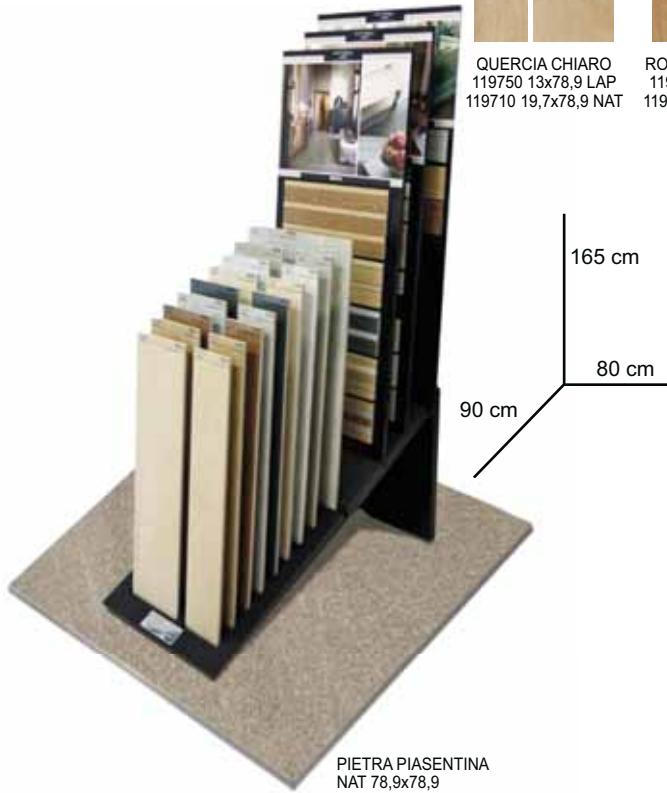

CULLA NATURAL

OGGETTO

6001116

CODICE

€ 320,00

PREZZO



- 119862 PROFILO ACCIAIO 1x79
- 119866 PROFILO BRONZO 1x79
- 119870 TORELLO PIETRA PIETRA S. GIORGIO 4x39,4
- 119945 FASCIA ETNIC PIETRA S. GIORGIO 6,4x39,4
- 119936 FASCIA ROSE ORO 13x39,4
- 119940 TOZZETTO ROSE PLATINO 13x13
- 119946 FASCIA ETNIC PIETRA SANTA MONICA 6.4x39,4
- 119947 FASCIA ETNIC PIETRA PIASENTINA 6.4x39,4
- 119920 MODULO LINEAR PIETRA S. GIORGIO 39,4x39,4
- 119921 MODULO LINEAR PIETRA SANTA MONICA 39,4x39,4
- 119922 MODULO LINEAR PIETRA PIASENTINA 39,4x39,4



- 119841 MOSAICO 12 MIX CASTAGNO/ROVERE NAT 39,4x39,4
- 119840 MOSAICO 12 MIX ROVERE NAT/QUERCIA CHIARO 39,4x39,4
- 119842 MOSAICO 12 MIX ROVERE ANTR/ROVERE GRIGIO CHIARO 39,4x39,4
- 119830 MOSAICO 32 MIX QUERCIA/ROVERE NAT/ PIETRA S. GIORGIO 39,4x39,4
- 119832 MOSAICO 32 MIX ROVERE ANTR/ROVERE GRIGIO/ PIETRA SANTA MONICA 39,4x39,4
- 119831 MOSAICO 32 MIX CASTAGNO/ROVERE NAT/ PIETRA PIASENTINA 39,4x39,4



- 17382 ROVERE GRIGIO 50x50
- 17380 ROVERE NATURALE 50x50
- 17381 CASTAGNO SCURO 50x50
- 17383 MULTICOLOR 50x50

PANNELLI ESPOSITORE 100,5x201 - 120,5x201

SCHEMA A
NA00001



fondo
19,7x78,9

fondo
13x78,9

€ 100,00

SCHEMA B
NA00002



fondo
13x78,9

€ 100,00

SCHEMA C
NA00003



fondo
39,4x78,9

€ 100,00

SCHEMA D
NA00004



fondo
50x50

€ 100,00

SCHEMA E
NA00005



fondo
13x78,9

fondo
19,7x78,9

fondo
39,4x78,9

€ 100,00

SCHEMA F
NA00006



fondo
19,7x78,9

fondo
13x78,9

€ 100,00

SCHEMA G
NA00007



fondo
13x78,9

tozzetto
13x13

€ 100,00

SCHEMA H
NA00008



fondo
19,7x78,9

mosaico
12 MIX

€ 100,00

NAGRAF1



TOZZETTI LEGNI:
 quercia nat e lap
 rovere nat e lap
 castagno nat e lap
 rovere grigio nat e lap
 rovere antracite nat e lap

TOZZETTI PIETRE:
 san giorgio nat e lap
 santa monica nat e lap
 piasentina nat e lap

TOZZETTI LEGNI PER ESTERNO:
 rovere grigio
 rovere naturale
 castagno scuro
 multicolor

€ 100,00

PER OGNI SCHEMA DI POSA SCELTO È NECESSARIO INDICARE NEL COMMENTO IL COLORE E LA SUPERFICIE (NAT O LAP) CHE SI VUOLE POSARE. LA FOTO VERRÀ APPLICATA DI CONSEGUENZA.

PANNELLI 60x200

SCHEMA A
NA10000

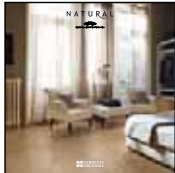

fondo
13x78,9

fondo
19,7x78,9

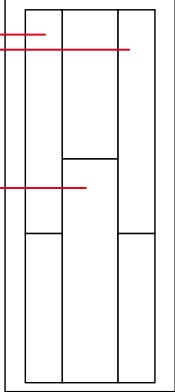

€ 100,00

SCHEMA B
NA10001

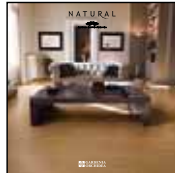

fondo
13x78,9

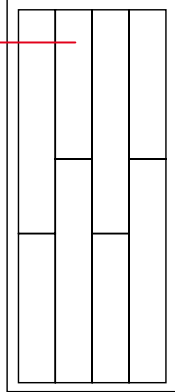

€ 100,00

SCHEMA C
NA10002

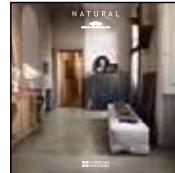

fondo
39,4x78,9

fondo
13x78,9

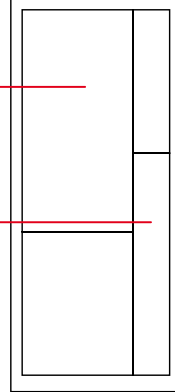

€ 100,00

SCHEMA D
NA10003

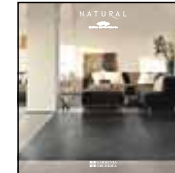

fascia
6,4x39,4

fondo
39,4x78,9

profilo
metallo

modulo
linear
39,4x39,4

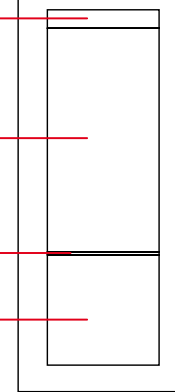

€ 100,00

SCHEMA E
NA10004

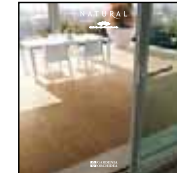

fondo
50x50
17383
multicolor

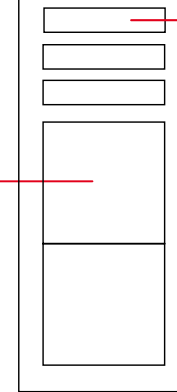

tozzetti per esterno
17380 rovere naturale
17381 castagno scuro
17382 rovere grigio chiaro

€ 100,00

**PER OGNI SCHEMA DI POSA
SCELTO È NECESSARIO INDICARE
NEL COMMENTO IL COLORE E LA
SUPERFICIE (NAT O LAP) CHE SI
VUOLE POSARE. LA FOTO VERRÀ
APPLICATA DI CONSEGUENZA.**



DEPLIANT ONICE

OGGETTO

6002073

CODICE

€ 2,00

PREZZO



AVORIO/BEIGE

61316 DECORO QUEEN OF FLOWERS AVORIO/BEIGE 19x49
61321 LISTELLO QUEEN OF FLOWERS AVORIO/BEIGE 6,1x49
61052 AVORIO 19x49



BIANCO

61330 DECORO GOLD FILLED (COMPOSIZIONE) 19x49
61336 LISTELLO GOLD FILLED 4,2x49
61050 BIANCO 19x49



AVVENTURINA

61255 DECORO DAMASCO NEUTRO AVVENTURINA 19x49
61285 LISTELLO TRAMATO ORO 4x49
61055 AVVENTURINA 19x49



GRIGIO/NERO

61050 BIANCO 19x49
61345 LISTELLO SWAROVSKI 1,3x49
61054 NERO 19x49



GRIGIO

61284 LISTELLO TRAMATO PLATINO 4x49
61051 QUARZO GRIGIO 19x49
117000 PROFILO ALLUMINIO ARGENTO 0,5x49
61161 LUSTRO TESSERA GRIGIO 19x49



TOZZETTARIO ONICE

OGGETTO

6000944

CODICE

€ 39,10

PREZZO



CULLA ONICE RIV

OGGETTO

6001071

CODICE

€ 500,00

PREZZO

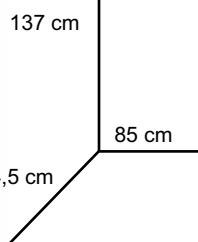

BEIGE

61213 TORELLO BEIGE 4x49
61263 DECORO DAMASCO ORO BEIGE 19x49
61233 MATITA BEIGE 1x49
61053 BEIGE 19x49

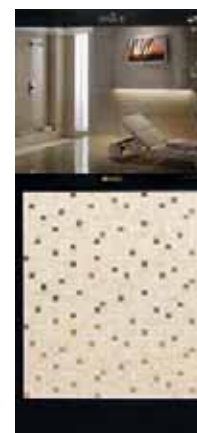

ORO/BEIGE

61201 MOSAICO TESSERA ORO BEIGE 19x49



GRIGIO

61171 MOSAICO GRECA GRIGIO 19x49



NERO

61164 MOSAICO TESSERA NERO 19x49

PANNELLI CULLA

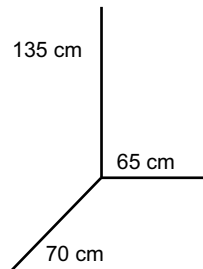

CULLA ONICE PAV

OGGETTO

6001070

CODICE

€ 350,00

PREZZO

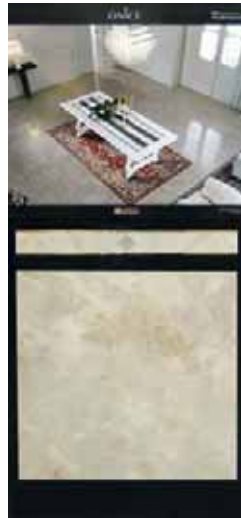

VERDE

17588 FASCIA SWAROVSKI VERDE 4,7x49
17638 VERDE 49x49
117101 PROFILO METALLO OTTONE 0,5x49



BEIGE

17633 BEIGE 49x49



AVVENTURINA

17635 AVVENTURINA 49x49



AVORIO

17632 AVORIO 49x49
117101 PROFILO METALLO OTTONE 0,5x49
17657 MOSAICO 450 MODULI NUVOLATO 24,5x49

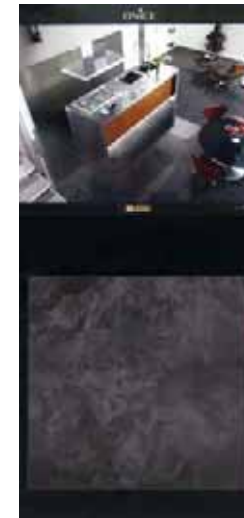

NERO

17634 NERO 49x49



BIANCO

17630 BIANCO 49x49
117102 PROFILO METALLO ACCIAIO 0,5x49
17654 MOSAICO 450 MODULI NERO 24,5x49

TOZZETTARIO ONICE

OGGETTO

6000944

CODICE

€ 39,10

PREZZO

PANNELLI 60x200



AVVENTURINA

OGGETTO

ON10010

CODICE

€ 125,00

PREZZO



GRIGIO

OGGETTO

ON10015

CODICE

€ 125,00

PREZZO



BIANCO

OGGETTO

ON10012

CODICE

€ 125,00

PREZZO



NERO

OGGETTO

ON10014

CODICE

€ 125,00

PREZZO

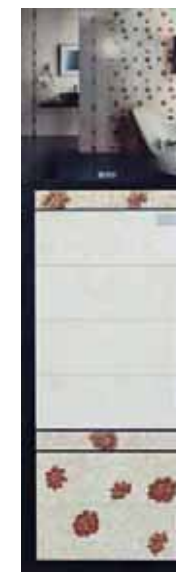

AVORIO

OGGETTO

ON10011

CODICE

€ 125,00

PREZZO



BEIGE

OGGETTO

ON10013

CODICE

€ 125,00

PREZZO

61323 LISTELLO QUEEN OF
FLOWERS AVVENTURINA 6,1x49
61055 AVVENTURINA 19x49
61285 LISTELLO TRAMATO ORO
4x49
61165 MOSAICO TESSERA
AVVENTURINA 19x49

117100 PROFILO ALLUMINIO
ARGENTO 0,5x49
61284 LISTELLO TRAMATO
PLATINO 4x49
61051 GRIGIO 19x49
117105 PROFILO ALLUMINIO
ARGENTO 1x49
61161 LUSTRO TESSERA GRIGIO
19x49

117100 PROFILO ALLUMINIO
ARGENTO 0,5x49
61284 LISTELLO PLATINO 4x49
61050 BIANCO 19x49
61171 LUSTRO GRECA GRIGIO
19x49

61336 LISTELLO GOLD FILLED
PLATINO 4,2x49
61054 NERO 19x49
117103 PROFILO ALLUMINIO
BRONZO 0,5x49
61330 GOLD FILLED
COMPOSIZIONE 2PZ 19x49

61321 LISTELLO QUEEN OF
FLOWERS AVORIO/BEIGE
6,1x49
61052 AVORIO 19x49
61316 QUEEN OF FLOWERS
AVORIO/BEIGE 19x49

61213 TORELLO BEIGE 4x49
61263 INSERTO DAMASCO ORO/
BEIGE 19x49
61233 MATITA BEIGE 1x49
61053 BEIGE 19x49
117103 PROFILO ALLUMINIO
BRONZO 0,5x49
61201 DECORO MOSAICO
TESSERA ORO/BEIGE 19x49

PANNELLI 100,5x201



AVORIO

OGGETTO

ONGRA12

CODICE

€ 125,00

PREZZO



AVVENTURINA

OGGETTO

ONGRA15

CODICE

€ 125,00

PREZZO



BEIGE

OGGETTO

ONGRA13

CODICE

€ 125,00

PREZZO



BIANCO

OGGETTO

ONGRA10

CODICE

€ 125,00

PREZZO



GRIGIO

OGGETTO

ONGRA11

CODICE

€ 125,00

PREZZO



NERO

OGGETTO

ONGRA14

CODICE

€ 125,00

PREZZO

61321 LISTELLO QUEEN OF FLOWER 6,1x49
61052 AVORIO 19x49
117103 PROFILO BRONZO 0,5x49
61316 DECORO QUEEN OF FLOWER 19x49

PAVIMENTI
17632 AVORIO LAP 49x49

61215 TORELLO AVVENTURINA 4x49
61304 LISTELLO ORO 4x49
61055 AVVENTURINA 19x49
61165 MOSAICO AVVENTURINA 19x49

PAVIMENTI
17635 AVVENTURINA LAP 49x49

61213 TORELLO BEIGE 4x49
61263 INSERTO DAMASCO 19x49
61233 MATITA BEIGE 1x49
61053 BEIGE 19x49
117103 PROFILO BRONZO 0,5x49
61201 MOSAICO TESSERA/ORO 19x49

PAVIMENTI
17633 BEIGE LAP 49x49

61211 TORELLO GRIGIO 4x49
117100 PROFILO ARGENTO 0,5x49
61280 LISTELLO TRAMATO 4x49
61050 BIANCO 19x49
61171 MOSAICO GRECA 19x49

PAVIMENTI
17630 BIANCO LAP 49x49

117100 PROFILO ARGENTO 0,5x49
61284 LISTELLO TRAMATO 4x49
61051 GRIGIO 19x49
117105 PROFILO ARGENTO 1x49
61161 MOSAICO TESSERA 19x49

PAVIMENTI
17630 BIANCO LAP 49x49

61336 LISTELLO GOLD FILLED 4,2x49
61054 NERO 19x49
117103 PROFILO BRONZO 0,5x49
61330 INSERTO GOLD FILLED 19x49

PAVIMENTI
17634 NERO LAP 49x49

PANNELLI 100,5x201 - 120,5x201

Avorio
ONGRAF2

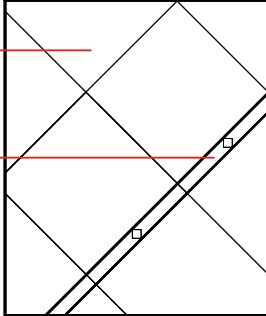



17632 avorio
49x49

17582 fascia
Swarovski
4,7x49

€ 115,00

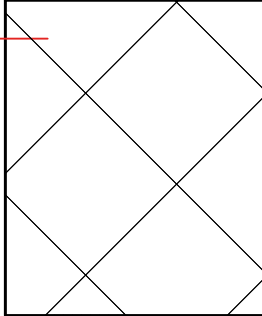
Verde
ONGRAF8

17638 verde
49x49

€ 115,00

Beige
ONGRAF3

17633 beige
49x49

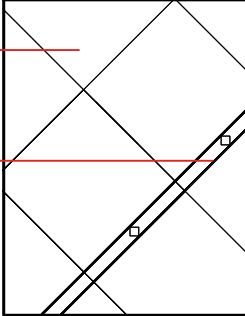
17583 fascia
Swarovski
beige 4,7x49

€ 115,00

Riassuntivo
ONGRAF9



17634 NERO LAPPATO

TOZZETTI COLORE:

DIAMANTE BIANCO NAT E LAP
ANDALUSITE BEIGE NAT E LAP
PERLA AVORIO NAT E LAP
AVVENTURINA NAT E LAP
VERDE NAT E LAP
NERO PERLA NAT E LAP

€ 115,00

Avventurina
ONGRAF5

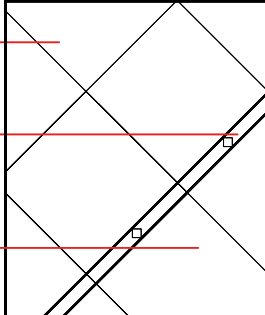
17635 avventurina
49x49

17585 fascia
Swarovski
avventurina 4,7x49

17635 avventurina
49x49

€ 115,00

Bianco
ONGRAF0

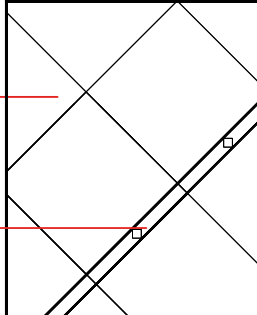



17630 bianco
49x49

17580 fascia
Swarovski
bianco 4,7x49

€ 115,00

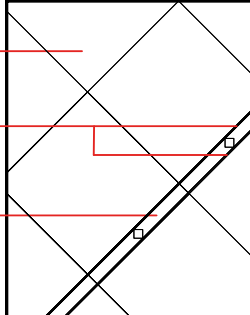
Nero
ONGRAF4

17634 nero
49x49

117102 profilo
acciaio 0,5x49

17584 fascia
Swarovski
nero 4,7x49

€ 130,00



DEPLIANT OPEN SPACE

OGGETTO

6002116

CODICE

€ 2,00

PREZZO



RASTRELLIERA OPEN SPACE

OGGETTO

Indicare: 1 codice rastrelliera +
1 codice materiale
(vedi rastrelliere pag. 10)

CODICE

€ 240,00 (culla lineare Absolute Stone)
€ 298,00 (culla in salita Absolute Stone)

PREZZO



TOZZETTARIO OPEN SPACE

OGGETTO

6000984

CODICE

€ 39,10

PREZZO



ESEMPIO:

RASTRELLIERA GRANDI FORMATI IN SALITA
+ 7pz OPEN SPACE 60x120 o 120x120

COD 6001090 + COD 6001110

€ 298,00

PANNELLI 100,5x201 - 120,5x201

Tortora OS00001/A

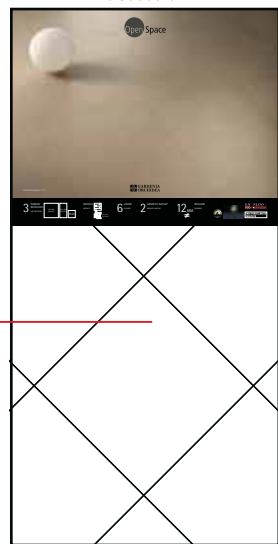

Fondo 60x60

€ 105,00

Beige OS00001/B



Fondo 60x60

Fondo 60x120

€ 105,00

Grigio Medio OS00001/C



Fondo 120x120

€ 105,00

PER OGNI SCHEMA DI POSA SCELTO È NECESSARIO INDICARE NEL COMMENTO IL COLORE E LA SUPERFICIE (NAT O LAP) CHE SI VUOLE POSARE. LA FOTO VIENE APPLICATA DI CONSEGUENZA.

GLI SCHEMI B-C SONO SOLO PER PANNELLI 120,5x201

RIASSUNTIVO OSGRAF1

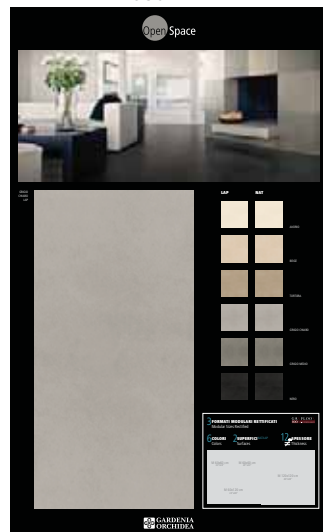

€ 105,00

27332 GRIGIO CHIARO LAP 60x120

TOZZETTI COLORE:

AVORIO NAT E LAP
BEIGE NAT E LAP
TORTORA NAT E LAP
GRIGIO CHIARO NAT E LAP
GRIGIO MEDIO NAT E LAP
NERO NAT E LAP



PANNELLO OPEN SPACE WENGE'
cm 200x250

OGGETTO

OPS0001

CODICE

€ 750,00

PREZZO



DEPLIANT PERLA

OGGETTO

6002066

CODICE

€ 2,00

PREZZO

PANNELLI CULLA



BIANCO/ANTRACITE

- 60031 INSERTO PERLINE BIANCO/
PLATINO 20x50
- 61015 BIANCO 20x50
- 60076 LISTELLO PERLINE
ANTRACITE 3x50
- 61040 ANTRACITE 20x50



CREMA/GIALLO

- 60000 INSERTO NEOBAROCCO
20x50
- 61000 CREMA 20x50
- 61003 LISTELLO NEOBAROCCO
GIALLO 2,5x50
- 61020 GIALLO 20x50

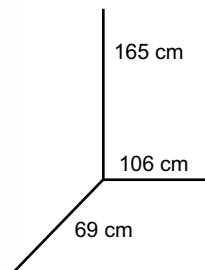

CULLA PERLA

OGGETTO

6001045

CODICE

€ 150,00

PREZZO



19670 CREMA 33,3x33,3



19671 BIANCO 33,3x33,3



19672 GIALLO 33,3x33,3



19676 ANTRACITE 33,3x33,3

PANNELLI 60x200



ANTRACITE

OGGETTO

PE10002

CODICE

€ 100,00

PREZZO

60076 LISTELLO PERLINE ANTRACITE 3x50
61015 BIANCO 20x50
60031 INSERTO PERLINE BIANCO 20x50
61040 ANTRACITE 20x50



GIALLO

OGGETTO

PE10005

CODICE

€ 100,00

PREZZO

60102 TORELLO GIALLO 4x50
61000 CREMA 20x50
61003 LISTELLO NEOBAROCCO 2,5x50
60015 FASCIA FLOREALE CREMA 20x50
60122 MATITA GIALLO 1x50
61020 GIALLO 20x50

PANNELLI 100,5x201



PERLA
GIALLO

OGGETTO

PEGRAF5

CODICE

€ 100,00

PREZZO

62102 TORELLO GIALLO 4x50
61000 CREMA 20x50
61003 LISTELLO NEOBAROCCO 2,5x50
60015 FASCIA FLOREALE CREMA 20x50
60123 MATITA GIALLA 1x50
61020 GIALLO 20x50

PAVIMENTI

19670 CREMA 33,3x33,3
19672 GIALLO 33,3x33,3



PERLA
ANTRACITE

OGGETTO

PEGRAF9

CODICE

€ 100,00

PREZZO

60101 TORELLO BIANCO 4x50
60076 LISTELLO PERLINE 3x50
61015 BIANCO 20x50
60031 INSERTO PERLINE 20x50
61045 PROFILO ARGENTO 0,5x50
61040 ANTRACITE 20x50

PAVIMENTI

19671 BIANCO 33,3x33,3
19676 ANTRACITE 33,3x33,3



DEPLIANT PIETRA DEL NORD

OGGETTO

6002111

CODICE

€ 2,00

PREZZO



TOZZETTARIO PIETRA DEL NORD

OGGETTO

6000983

CODICE

€ 39,10

PREZZO



CULLA PIETRA DEL NORD

OGGETTO

6001108

CODICE

€ 180,00

PREZZO

PANNELLI CULLA



TORTORA

15442 TORTORA LAPPATO 60x60
15482 MOSAICO TORTORA 30x30
15472 FASCIA TORTORA 8x30



GRIGIO

15453 GRIGIO LAPPATO 60x60
15433 GRIGIO NATURALE 30x30



ORO

15441 ORO LAPPATO 60x60



BEIGE

15440 BEIGE LAPPATO 60x60

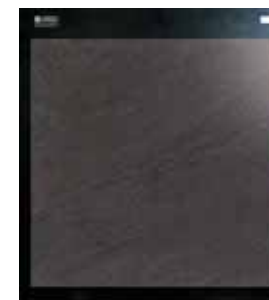

NERO

15444 NERO LAPPATO 60x60

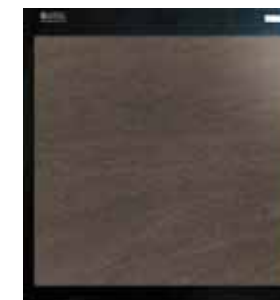

MOKA

15445 MOKA LAPPATO 60x60

PANNELLI 100,5x201 - 120,5x201

Beige
PN00010



15440 beige lap 60x60

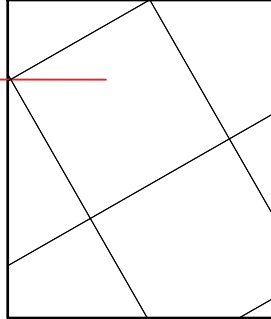

€ 95,00

Oro
PN00011



15441 oro lap 60x60

15461 oro lap 30x30

15451 oro lap 30x60

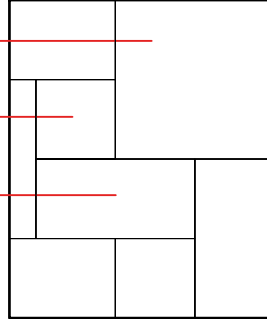

€ 95,00

Tortora
PN00012



15422 tortora nat 30x60

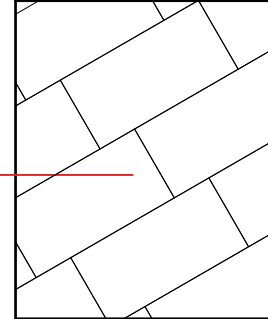

€ 95,00

Grigio
PN00013



15443 grigio lap 60x60

15483 mosaico grigio 30x30

15453 grigio lap 30x60

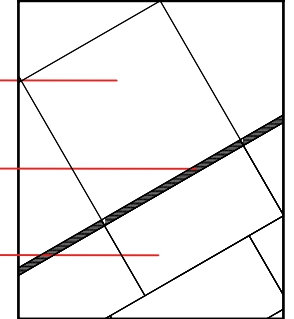

€ 95,00

Nero
PN00014



15444 nero lap 60x60

15484 mosaico nero 30x30

15454 nero lap 30x60

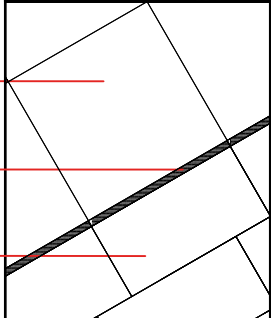

€ 95,00

Moka
PN00015



15445 moka lap 60x60

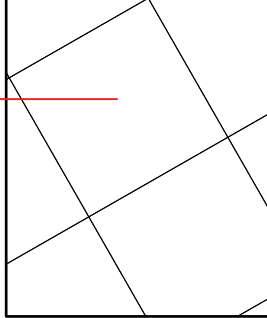

€ 95,00

Tortora
PN00016



15442 tortora lap 60x60

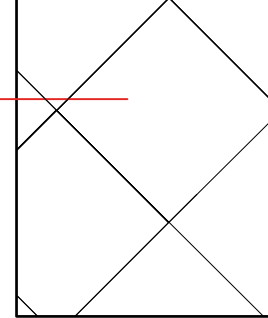

€ 95,00

PANNELLI CULLA



DEPLIANT TEXTILE

OGGETTO

6002084

CODICE

€ 2,00

PREZZO

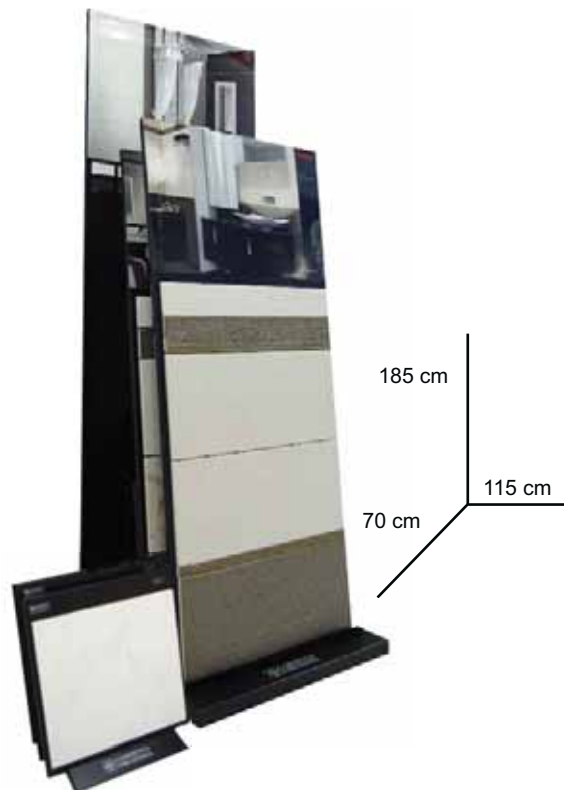

CULLA TEXTILE

OGGETTO

6001087

CODICE

€ 240,00

PREZZO



BIANCO/ANTRACITE

- 66000 BIANCO 25x60
- 66121 LISTELLO ANTRACITE 7,8x60
- 66115 MODULO AUTUNNO BIANCO 25x60
- 66126 LISTELLO SILVER 3,2x60
- 66003 ANTRACITE 25x60



AVORIO/MOKA

- 66001 AVORIO 25x60
- 66120 LISTELLO AUTUNNO MOKA 7,8x60
- 66116 MODULO AUTUNNO AVORIO 14x60
- 66125 LISTELLO GOLD 3,2x60
- 67005 MOKA 25x60

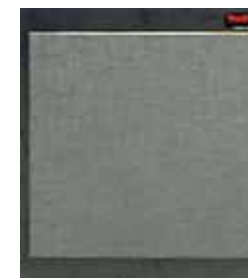

14411 ANTRACITE 41x41



14410 MOKA 41x41

PANNELLI 60x200



BIANCO/ANTRACITE

OGGETTO

TX10001

CODICE

€ 86,00

PREZZO



AVORIO/MOKA

OGGETTO

TX10003

CODICE

€ 86,00

PREZZO

66003 ANTRACITE 25x60
66121 LISTELLO AUTUNNO ANTRACITE 7,8x60
66126 LISTELLO AUTUNNO SILVER 3,2x60
67160 PROFILO ARGENTO 0,5x60
66000 BIANCO 25x60

66002 MOKA 25x60
66125 LISTELLO AUTUNNO GOLD 3,2x60
66116 MODULO AUTUNNO AVORIO 25x60
66120 LISTELLO AUTUNNO MOKA 7,8x60
67161 PROFILO BRONZO 0,5x60
66001 AVORIO 25x60

PANNELLI 100,5x201



AVORIO/MOKA

OGGETTO

TXGRAF3

CODICE

€ 86,00

PREZZO

66001 AVORIO 25x60
66120 LISTELLO AUTUNNO 7,8x60
66116 MODULO AUTUNNO 25x60
66125 LISTELLO AUTUNNO GOLD 3,2x60
67161 PROFILO BRONZO 0,5x60
66002 MOKA 25x60

PAVIMENTI
14110 MOKA 41x41



BIANCO/ANTRACITE

OGGETTO

TXGRAF2

CODICE

€ 86,00

PREZZO

66000 BIANCO 25x60
66121 LISTELLO AUTUNNO 7,8x60
66115 MODULO AUTUNNO 25x60
66126 LISTELLO AUTUNNO GOLD 3,2x60
67160 PROFILO ALLUMINIO 0,5x60
66003 ANTRACITE 25x60

PAVIMENTI
14111 ANTRACITE 41x41



**DEPLIANT
VARENNA**

OGGETTO

6002123

CODICE

€ 2,00

PREZZO



**TOZZETTARIO
VARENNA**

OGGETTO

6000993

CODICE

€ 39,10

PREZZO

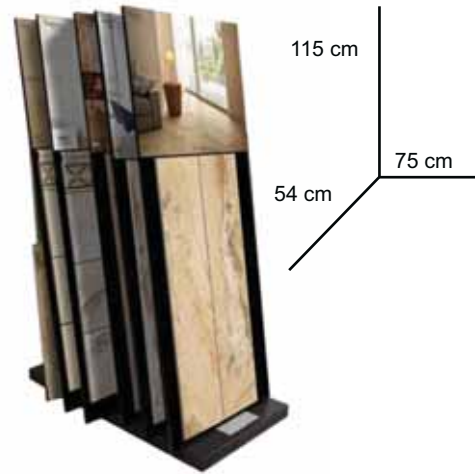

CULLA VARENNA

OGGETTO

6001122

CODICE

€ 300,00

PREZZO

PANNELLI CULLA



NOCE

87306 NOCE NAT 19,7x78,9



BEIGE

87305 BEIGE NAT 19,7x78,9



SILVER

87307 SILVER NAT 19,7x78,9



17806 NOCE NAT 50x50



87322 SILVER LAP 39,4x78,9



BEIGE

61510 TORELLO BEIGE 4x50
61520 LISTELLO BEIGE 6,2x50
61515 MATITA BEIGE 1x50
61500 BEIGE 20x50



SILVER

61511 TORELLO SILVER 4x50
61521 LISTELLO SILVER 6,2x50
61516 MATITA SILVER 1x50
61502 SILVER 20x50

PANNELLI 100,5x201



BEIGE

OGGETTO

VAGRAF1

CODICE

€ 90,00

PREZZO

61510 TORELLO BEIGE 4x50
61520 LISTELLO BEIGE 6,2x50
61515 MATITA BEIGE 1x50
61500 BEIGE 20x50

PAVIMENTI

87310 BEIGE NAT 39,4x39,4



BIANCO/ANTRACITE

OGGETTO

VAGRAF2

CODICE

€ 90,00

PREZZO

61511 TORELLO SILVER 4x50
61521 LISTELLO SILVER 6,2x50
61516 MATITA SILVER 1x50
61502 SILVER 20x50

PAVIMENTI

87312 SILVER NAT 39,4x39,4

PANNELLI 60x200



BEIGE

OGGETTO

VA10001

CODICE

€ 90,00

PREZZO

61510 TORELLO BEIGE 4x50
61520 LISTELLO BEIGE 6,2x50
61515 MATITA BEIGE 1x50
61500 BEIGE 20x50

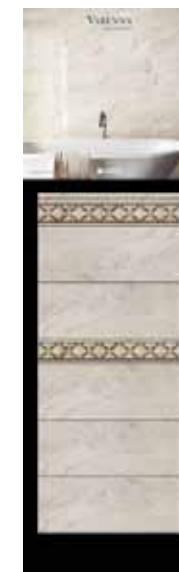

SILVER

OGGETTO

VA10002

CODICE

€ 90,00

PREZZO

61511 TORELLO SILVER 4x50
61521 LISTELLO SILVER 6,2x50
61516 MATITA SILVER 1x50
61502 SILVER 20x50

PANNELLI PAVIMENTI 100,5x201 - 120,5x201

SCHEMA A
VA00001



fondo
39,4x78,9

€ 90,00

SCHEMA B
VA00002

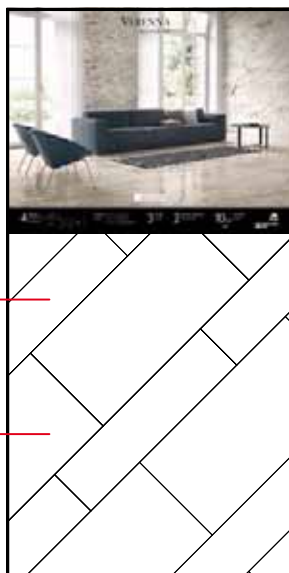

fondo
19,7x78,9

fondo
39,4x78,9

€ 90,00

SCHEMA C
VA00003



fondo
19,7x78,9

€ 90,00

SCHEMA D
VA00004

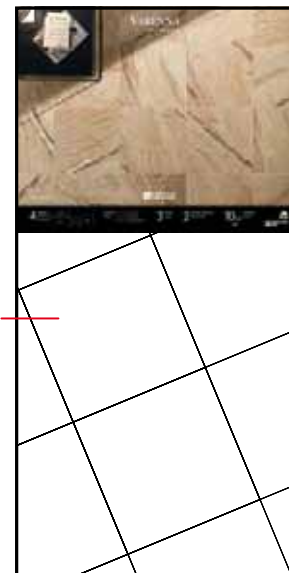

fondo
50x50

€ 90,00

SCHEMA E
VA00005

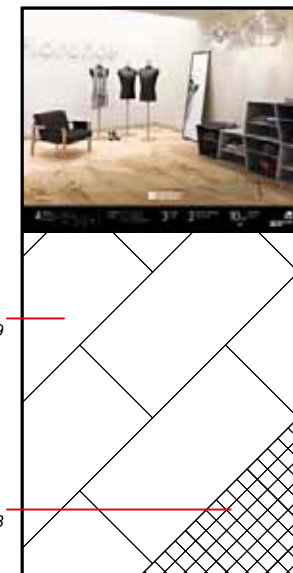

fondo
39,4x78,9

mosaico
33,3x33,3

€ 90,00

PER OGNI SCHEMA DI POSA È NECESSARIO INDICARE IL COLORE E LA SUPERFICIE (NAT O LAP) CHE SI VUOLE POSARE. LA FOTO VERRÀ APPLICATA DI CONSEGUENZA.



DEPLIANT VELVET

OGGETTO

6002097

CODICE

€ 2,00

PREZZO



CULLA VELVET

OGGETTO

6001093

CODICE

€ 250,00

PREZZO

PANNELLI CULLA



BEIGE/NOCE

- 2858 TORELLO NOCE 4x50
- 60266 LISTELLO DAMASCO BEIGE 6,2x50
- 60202 BEIGE 20x50
- 2648 MATITA NOCE 1x50
- 60261 DECORO DAMASCO BEIGE 20x50
- 60208 NOCE 20x50



BIANCO/ANTRACITE

- 2851 TORELLO ANTRACITE 4x50
- 60265 LISTELLO DAMASCO BIANCO 6,2x50
- 2641 MATITA ANTRACITE 1x50
- 60200 BIANCO 20x50
- 61045 PROFILO ARGENTO 0,5x50
- 60260 DECORO DAMASCO BIANCO 20x50
- 60201 ANTRACITE 20x50



BEIGE/MOKA

- 2853 TORELLO MOKA 4x50
- 61046 PROFILO BRONZO 0,5x50
- 60202 BEIGE 20x50
- 2643 MATITA MOKA 1x50
- 60226 LISTELLO CARTA DA PARATI 6,2x50
- 60203 MOKA 20x50



ANTRACITE

14171 ANTRACITE 41x41



BIANCO

14170 BIANCO 41x41



BEIGE

14172 BEIGE 41x41



MOKA

14173 MOKA 41x41



**BIANCO/ANTRACITE
BEIGE/MOKA**

- 14180 BIANCO LAPPATO 41x41
- 14181 ANTRACITE LAPPATO 41x41
- 14182 BEIGE LAPPATO 41x41
- 14183 MOKA LAPPATO 41x41

PANNELLI 60x200



BEIGE/NOCE

OGGETTO

VE10001

CODICE

€ 90,00

PREZZO



BIANCO/ANTRACITE

OGGETTO

VE10002

CODICE

€ 90,00

PREZZO



BEIGE/MOKA

OGGETTO

VE10003

CODICE

€ 90,00

PREZZO

2858 TORELLO NOCE 4x50
60266 LISTELLO DAMASCO BEIGE 6,2x50
2648 MATITA NOCE 1x50
60202 VELVET BEIGE 20x50
60261 DECORO DAMASCO BEIGE 20x50
60208 VELVET NOCE 20x50

2851 TORELLO ANTRACITE 4x50
60265 LISTELLO DAMASCO BIANCO 6,2x50
2641 MATITA ANTRACITE 1x50
60200 VELVET BIANCO 20x50
61045 PROFILO ARGENTO 0,5x50
60260 DECORO DAMASCO BIANCO 20x50
60201 VELVET ANTRACITE 20x50

2853 TORELLO MOKA 4x50
60226 LISTELLO CARTA DA PARATI 6,2x50
2643 MATITA MOKA 1x50
60202 VELVET BEIGE 20x50
60203 VELVET MOKA 20x50

PANNELLI 100,5x201



BIANCO/ANTRACITE

OGGETTO

VEGRAF6

CODICE

€ 90,00

PREZZO

2851 TORELLO ANTRACITE 4x50
60265 LISTELLO DAMASCO 6,2x50
60200 BIANCO 20x50
60260 DECORO DAMASCO 20x50
60201 ANTRACITE 20x50

PAVIMENTI

14170 BIANCO NAT 41x41
14171 ANTRACITE NAT 41x41



BEIGE/MOKA

OGGETTO

VEGRAF2

CODICE

€ 90,00

PREZZO

2853 TORELLO MOKA 4x50
60226 LISTELLO CARTA DA PARATI
6,2x50
60202 BEIGE 20x50
2643 MATITA MOKA 1x50
60203 MOKA 20x50

PAVIMENTI

14172 BEIGE NAT 41x41
14173 MOKA NAT 41x41



BEIGE/NOCE

OGGETTO

VEGRAF3

CODICE

€ 90,00

PREZZO

2858 TORELLO NOCE 4x50
60266 LISTELLO DAMASCO 6,2x50
60202 BEIGE 20x50
60261 DECORO DAMASCO 25x60
2648 MATITA NOCE 1x50
60208 NOCE 25x60

PAVIMENTI

14172 BEIGE NAT 41x41

PANNELLI 100,5x201 - 120,5x201

Beige/Moka
VEGRAF4

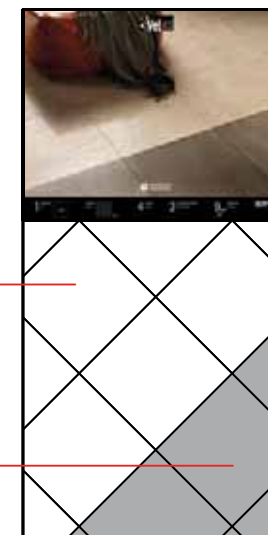

14182 beige
41x41

14183 moka
41x41

€ 88,00

Bianco/Antracite
VEGRAF5



14180 bianco
41x41

14181 antracite
41x41

€ 88,00



DEPLIANT VIA DELLA SETA

OGGETTO

6002047

CODICE

€ 2,00

PREZZO

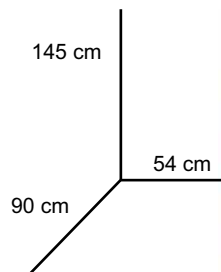

CULLA VIA DELLA SETA

OGGETTO

6001044

CODICE

€ 210,00

PREZZO

PANNELLI CULLA



AMBRE

17535 AMBRE 45x45
13335 MOSAICO 64 MODULI 45x45



CHANVRE

17531 CHANVRE 45x45
13331 MOSAICO 64 MODULI 45x45



SABLE

13352 MOSAICO MURETTO 45x45
17532 SABLE 45x45
13332 MOSAICO 64 MODULI 45x45



IVOYRE

17530 IVOYRE 45x45
13330 MOSAICO 64 MODULI 45x45



PAPYRUS

17534 PAPYRUS 45x45
13334 MOSAICO 64 MODULI 45x45



POIVRE

17533 POIVRE 45x45
13333 MOSAICO 64 MODULI 45x45

PANNELLI 100,5x201 - 120,5x201

Ivoyre
VS00005



17530 ivoyre
45x45

13330 mosaico
64 moduli 45x45

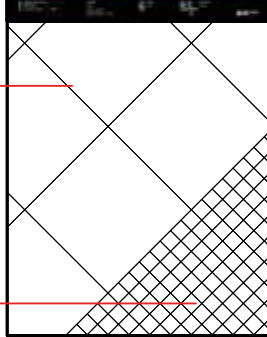

€ 95,00

Chanvre
VS00003



17531 chanvre
45x45

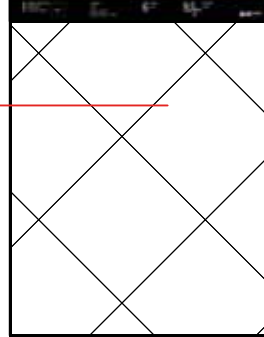

€ 95,00

Sable
VS00007



17532 sable
45x45

13352 mosaico
muretto 45x45

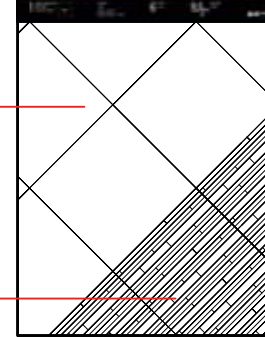

€ 95,00

Poivre
VS00002



17533 poivre
45x45

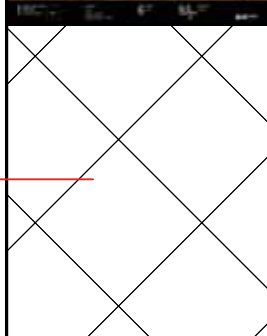

€ 95,00

Papyrus
VS00006



17534 papyrus
45x45

13354 mosaico
muretto 45x45

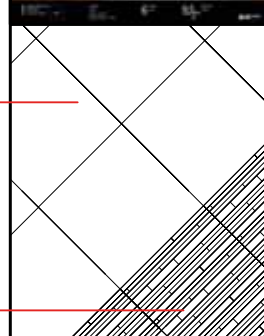

€ 95,00

Ambre
VS00001



17535 ambre
45x45

13355 mosaico
64 moduli 45x45

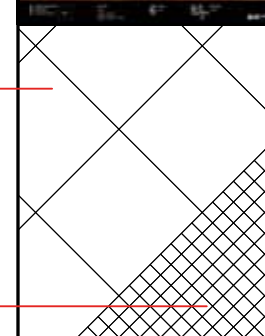

€ 95,00

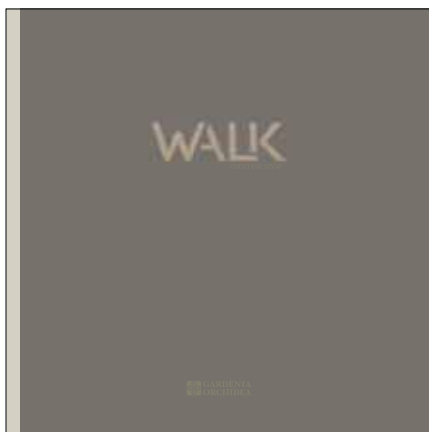

CATALOGO WALK

OGGETTO

6002124

CODICE

€ 10,40

PREZZO



TOZZETTARIO WALK

OGGETTO

6000995

CODICE

€ 39,10

PREZZO



RASTRELLIERA WALK

OGGETTO

Indicare: 1 codice rastrelliera +
1 codice materiale
(vedi rastrelliere pag. 10)

CODICE

€ 168,00 (culla lineare Walk)

€ 218,00 (culla in salita Walk)

PREZZO



ESEMPIO:

RASTRELLIERA
GRANDI FORMATI IN SALITA +
7pz WALK 80x80

COD 6001090 + COD 6001119

€ 218,00

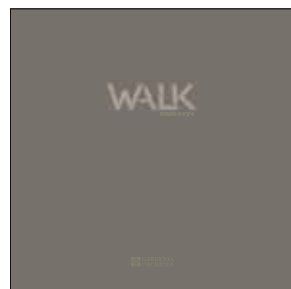

DEPLIANT WALK

OGGETTO

6002125

CODICE

€ 2,00

PREZZO

PANNELLI CULLA

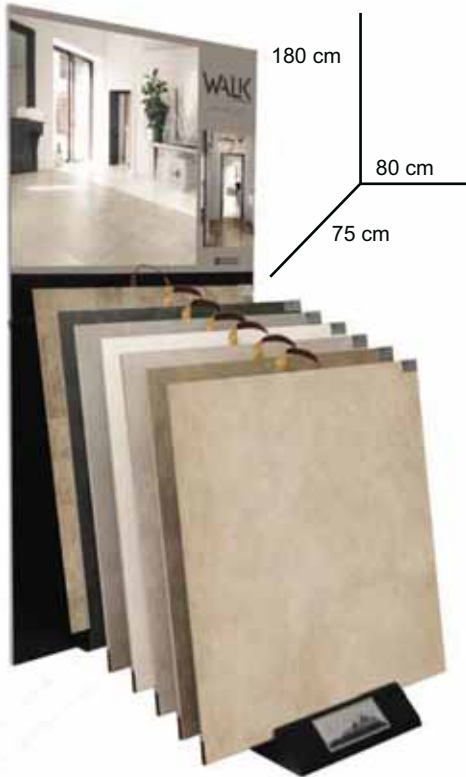

BEIGE
41250 BEIGE/FANGO DECORATO 80x80



BEIGE
41200 BEIGE 80x80



FANGO
41201 FANGO 80x80



GRIGIO MEDIO
41202 GRIGIO MEDIO 80x80



ANTRACITE
41203 ANTRACITE 80x80



GRIGIO CHIARO
41204 GRIGIO CHIARO 80x80



BIANCO
41205 BIANCO 80x80

CULLA WALK

OGGETTO

6001124

CODICE

€ 230,00

PREZZO

PANNELLI CULLA



136 cm

68 cm

78 cm

CULLA WALK

OGGETTO

6001125

CODICE

€ 260,00

PREZZO



BEIGE

41300 MOSAICO T20 BEIGE/GOLD
33,3x33,3
41260 BEIGE 30x60
41240 BEIGE 15x60



FANGO

41231 FANGO 60x60



ANTRACITE

41313 MOSAICO T36 ANTRACITE
33,3x33,3
41263 ANTRACITE 30x60
41243 ANTRACITE 15x60



GRIGIO CHIARO

41234 GRIGIO CHIARO 60x60



GRIGIO MEDIO

41282 GRIGIO MEDIO MIX
(15x60 - 10x60 - 5x60)



BIANCO

41245 BIANCO 30x60
41265 BIANCO 15x60

PANNELLI 100,5x201 - 120,5x201

SCHEMA A
WK00001

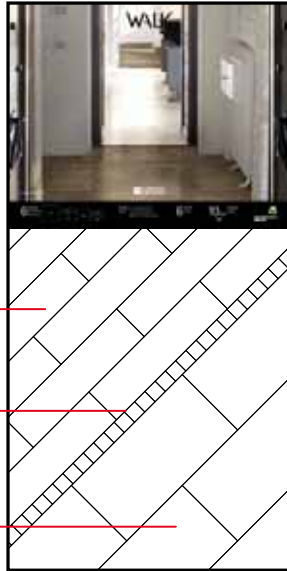

€ 100,00

SCHEMA B
WK00002



€ 100,00

SCHEMA C
WK00003



€ 100,00

SCHEMA D
WK00004



€ 100,00

SCHEMA E
WK00005

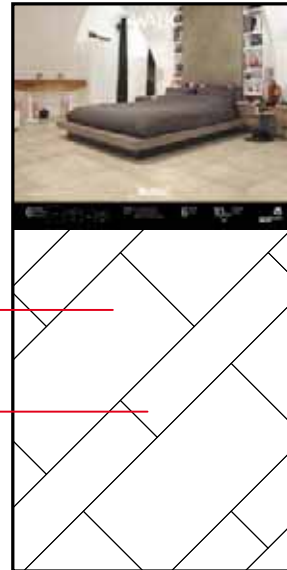

€ 100,00

SCHEMA F
WK00006



€ 100,00

PANNELLI 100,5x201 - 120,5x201

SCHEMA G
WK00007

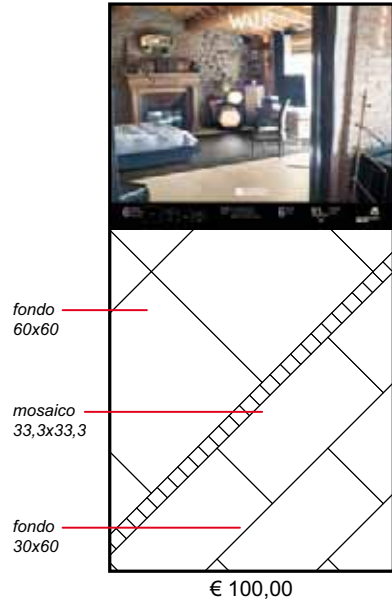

SCHEMA H
WK00008

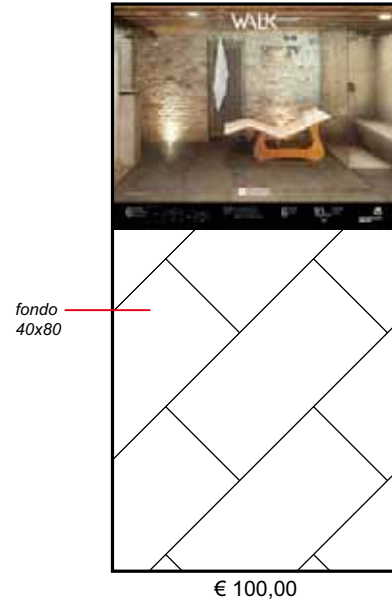

Riassuntivo
WKGRAF1

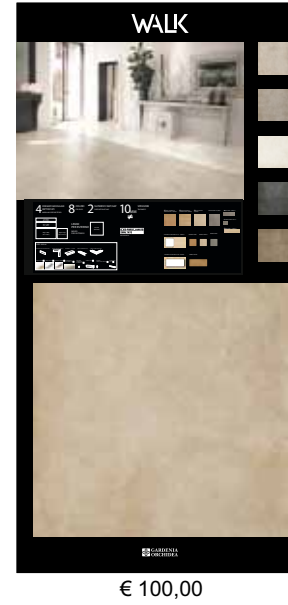

PANNELLI 120,5x201

SCHEMA I
WK00009

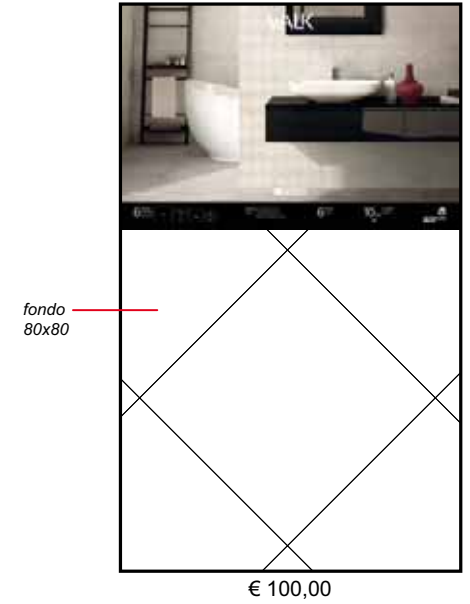



Ceramiche Gardenia Orchidea S.p.A. - Via Canaletto, 27 - 41042 Spezzano di Fiorano, MO (Italy)
Tel. 0536 849611 - Fax 0536 849856 - info@gardenia.it - www.gardenia.it